



Welcome to our newest interactive and digitally optimized tire range!



Skip instructions



Tap or click here for more



On the CONTENT page, simply click on the desired product segment to view the entire portfolio and deep dive into product details.

One step back



Tap or click again



Leads to chapter MTB

Leads to chapter ROAD

Leads to chapter GRAVEL

-> TUBES and so on...

For example, in the ROAD chapter you can go directly to each individual tire, to our website or directly back to CONTENT.

One step back



One last tap or click



AERO 111

Grand Prix 5000 AS TR

Grand Prix 5000 S TR

Grand Prix 5000 TT TR

Grand Prix 5000

Grand Prix

Go to a specific tire model

Grand Prix Urban

Ultra Sport III

Gator Hare

Gatorskin

Grand Sport

Hometrainer

Leads directly to ROAD on our website

Go back to CONTENT

And each product overview, click on the left icons to expand for further product details.

That's all you need to know. So feel free to have a look around and have fun!

Tap or click to start →



Go back to ROAD

Always leads back to this on the following pages

To the specific details of the tire

Go back to CONTENT

Leads directly to the tires website



Continental 
The Future in Motion



BICYCLE

Tire Range **2024/25**



ROAD



MTB



GRAVEL



URBAN



TUBULAR



E-BIKE



TECH

TIRES & SIZES

TUBES

SUPPORT

AERO 111

Grand Prix 5000 AS TR

Grand Prix 5000 S TR

Grand Prix 5000 TT TR

Grand Prix 5000

Grand Prix

Grand Prix 4-Season

Grand Prix Urban

Ultra Sport III

Gator Hardshell

Gatorskin

Grand Sport Race

Hometrainer

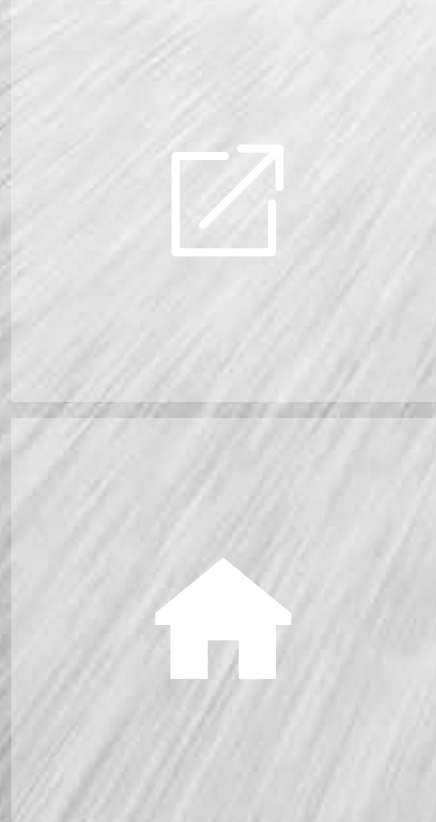

ROAD

AERO 111



TECHNOLOGY



SIZES



FEATURES



NEW



TECHNOLOGY



SIZES



FEATURES



A PERFECTED STORM

Extensively tested in the wind tunnel, the AERO 111 represents the ultimate aerodynamic tire without compromise. To save every watt we created the unique tread pattern together with the experts at Swiss Side.



BlackChili compound is renowned for its perfect balance of grip and low rolling resistance. For AERO 111 we use a race-optimized BlackChili, offering low rolling resistance in combination with excellent grip in wet and dry conditions.



Vectran, our patented technology from the GP5000 family. Selected for AERO 111 because of its unparalleled level of protection from sharp foreign objects, whilst not affecting rolling resistance.



Swiss Side are the industry leader in aerodynamics. With over 20 years of experience in both Formula 1 and cycling, they are renowned for utilising the latest technologies and methodologies in computational aerodynamics and real-world testing.

The combination of all these features means on top of the low aerodynamic drag, the AERO 111 offers low rolling resistance, good puncture resistance and exceptional grip in both wet and dry conditions.

AERO 111

AERO 111

BlackChili Compound - Vectran Breaker - ACT - 2/220 TPI

TR

	Article	ETRTO	Dimension	Color/sidewall	g	PSI	EAN	RRP/€
NEW	0102046	26-622	28" 700 x 26C	● foldable	250	72-101	4 019238 283921	119,95
NEW	0102047	29-622	28" 700 x 29C	● foldable	280	72-101	4 019238 283907	119,95



CONTI KNOWLEDGE

Tubeless Ready:

For initial mounting we recommend to use at least 30 ml of Conti RevoSealant per tire. Then spin the tire (wheel) to spread the Conti RevoSealant inside of the tire and pump to the allowed maximum pressure. Check the pressure before the next ride and adjust to your desired PSI.



This tire is Hookless compatible to its limited max. pressure. Please check wheel instruction and tire packaging for detailed information.



TECHNOLOGY



SIZES



FEATURES



AERO 111



TECHNOLOGY



SIZES



FEATURES



AERODYNAMICS BY SWISS SIDE

The aero-optimized tread pattern certainly looks different: 48 little cavities are regularly distributed over its surface. These so-called **'vortex generators'** are the very feature that manage to control the turbulence in the airflow on the surface of the front wheel. Ultimately, this results in a perfected storm that allows for the reduction of drag of the entire wheel tire system.



All **Tubeless Ready** tires have been designed with versatility in mind. It's your choice: set up tubeless using Conti RevoSealant or use an innertube.

AERO 111



TECHNOLOGY



SIZES



FEATURES

Without AERO 111

The rider benefits less from the sailing effect because the early airflow separation increases the turbulent air flow. Thus, increasing aerodynamic drag of the wheel-tire system.

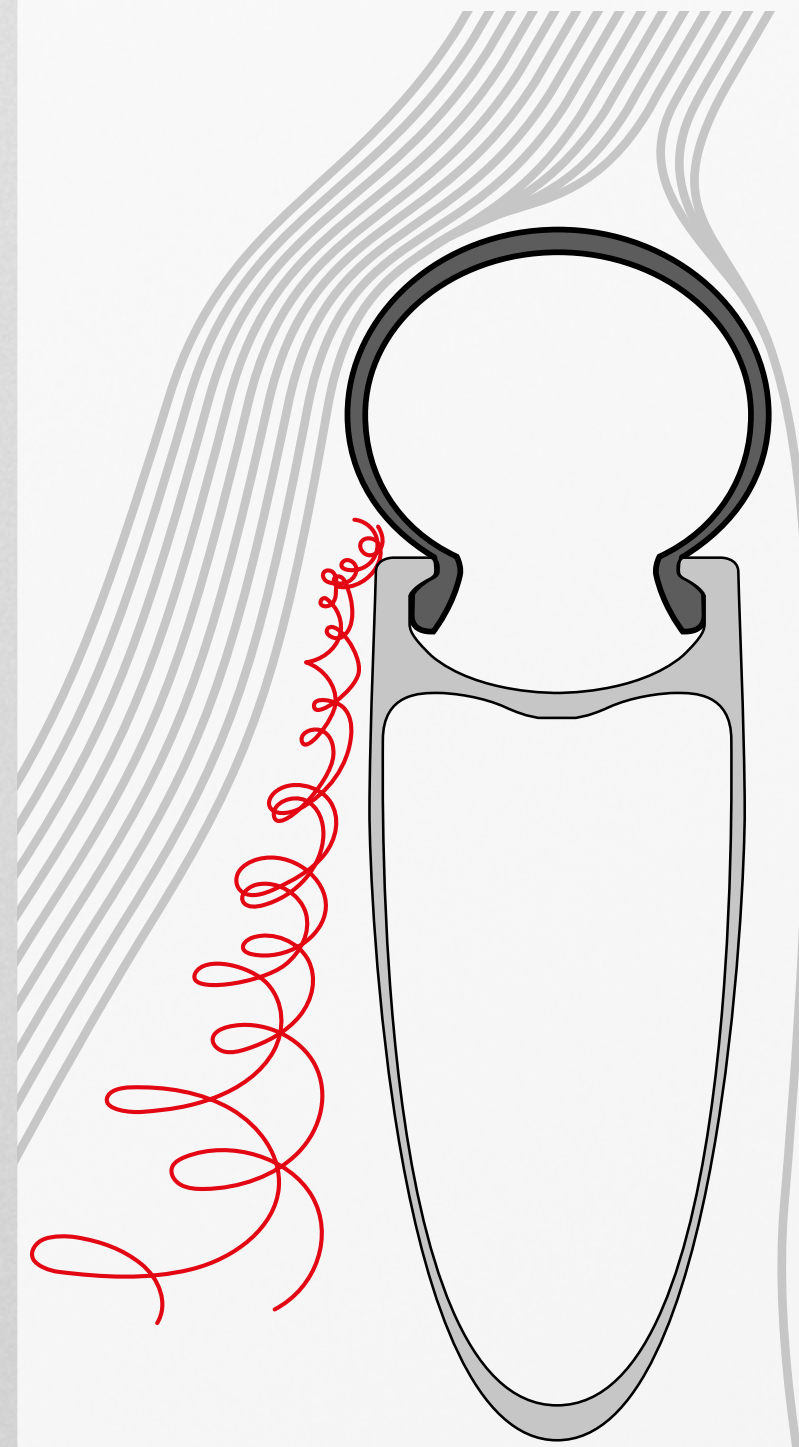

With AERO 111

The sailing effect (forward acting force) increases. Even with lower rim profiles the rider benefits from this effect because the laminar airflow stays adjacent to the rim for a longer time. Thus, decreasing aerodynamic drag of the wheel-tire system at all speeds.

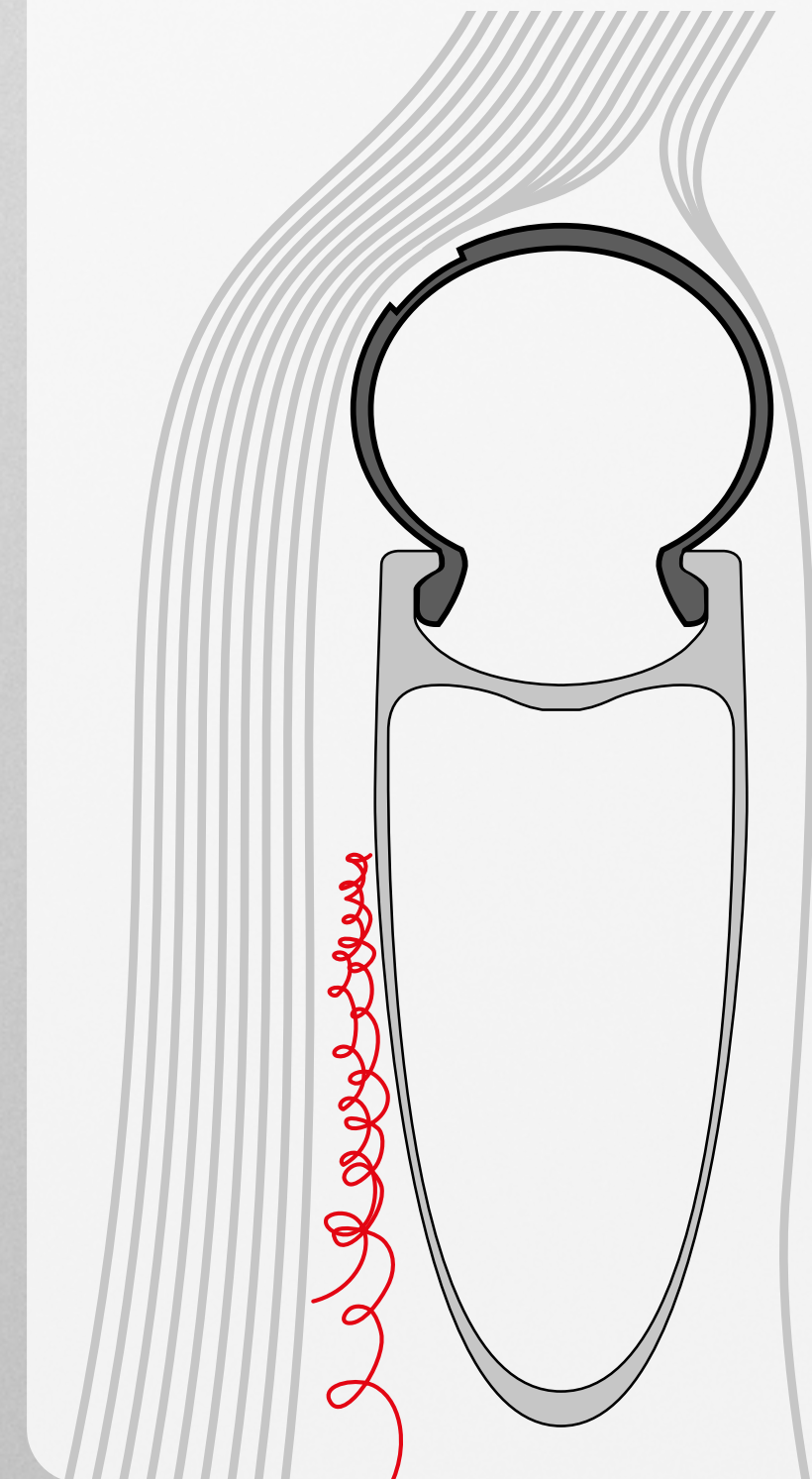

AERO 111



TECHNOLOGY



SIZES



FEATURES

45 KM/H - DRAG PERFORMANCE

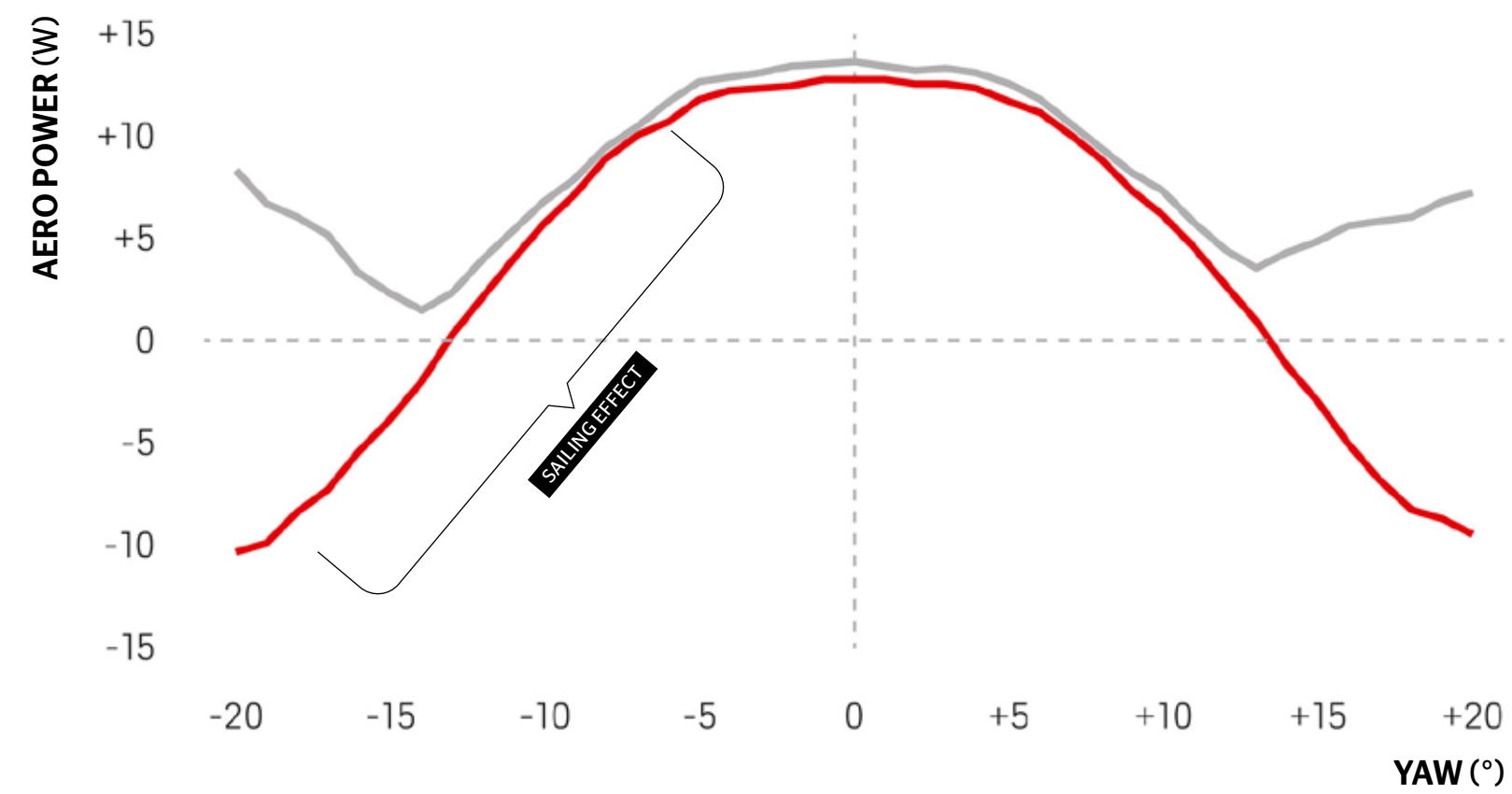

— DT Swiss ARC 1100 DICUT® DB 62
Continental **AERO 111** 26 mm, 45 km/h

— DT Swiss ARC 1100 DICUT® DB 62
Continental GP 5000 S TR 25 mm, 45 km/h

30 KM/H - DRAG PERFORMANCE

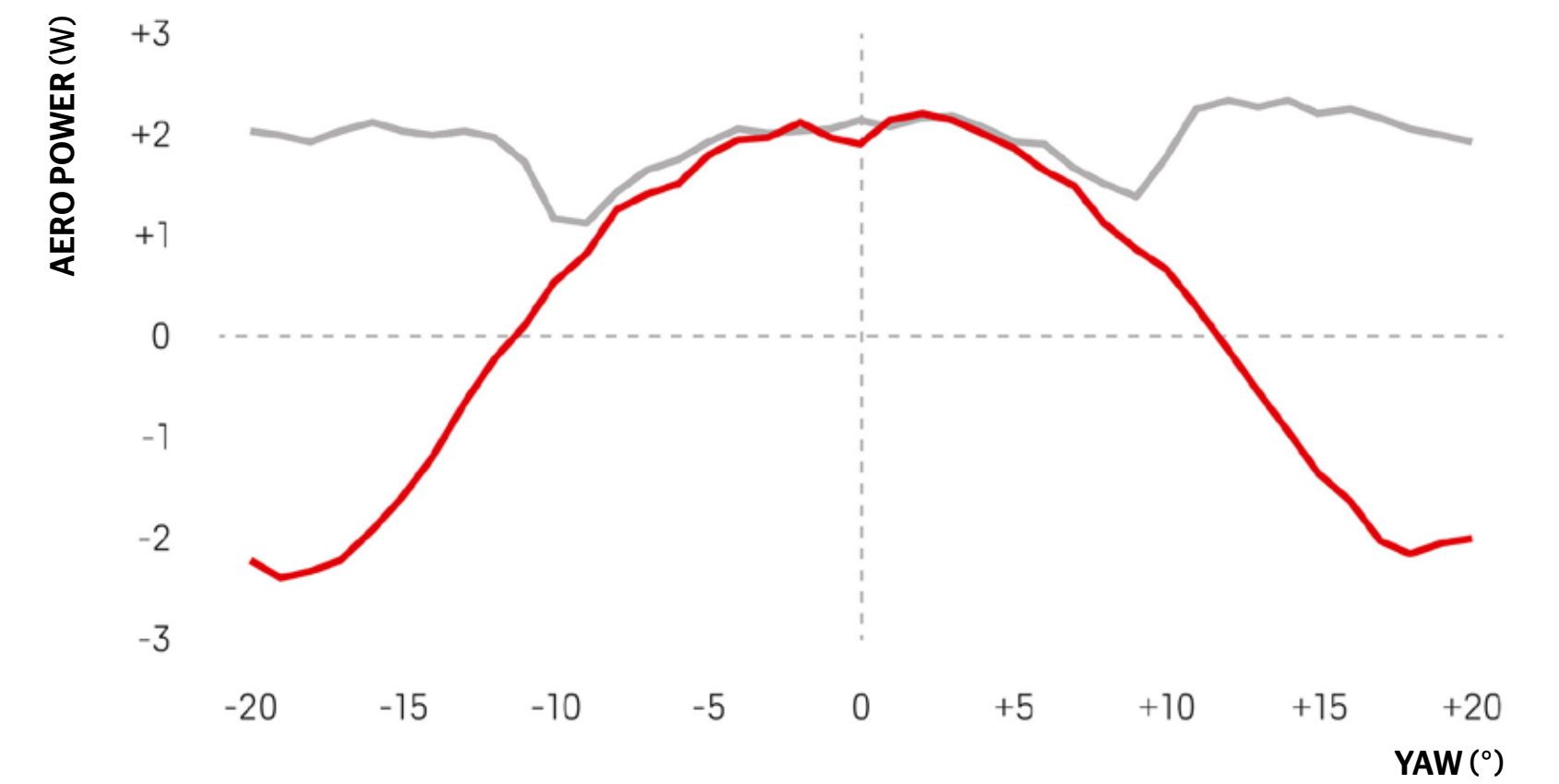

— DT Swiss ARC 1100 DICUT® DB 62
Continental **AERO 111** 26 mm, 30 km/h

— DT Swiss ARC 1100 DICUT® DB 62
Continental GP 5000 S TR 25 mm, 30 km/h

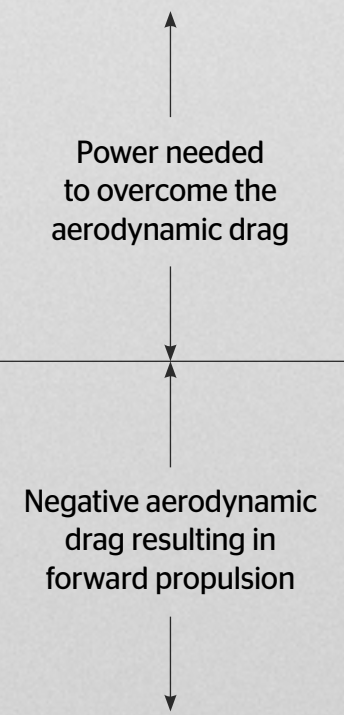

Grand Prix 5000 AS TR



TECHNOLOGY



SIZES



FEATURES



Grand Prix 5000 AS TR

FOR THE EXTRA MILE

The strongest Grand Prix 5000: creates trust in all weather conditions and boosts your protection.



TECHNOLOGY



SIZES



FEATURES



With our unique tread compound, we have revolutionized the sport of cycling. With the legendary **BlackChili Compound** we have answered the eternal question of the best balance of grip and rolling resistance for cycling. The latest polymers as well as specially developed carbon black particles and filler materials guarantee unique performance, be it on a road, gravel or a mountain bike, for time trialling or downhill.



The revolutionary approach in cycling. Embedded in the tire construction the **Active Comfort Technology** absorbs vibrations and smoothens your ride.



Vectran is spun from liquid crystal-polymer. This way a thermoplastic, multiple-thread yarn is created. As a comparison: This partially crystalline fabric is more cut-resistant than aramide and its tensile strength is five times higher than that of steel. A Vectran breaker is lighter, more flexible and effective against cuts than a comparable nylon breaker. Without effecting rolling resistance.



Lazer Grip, to make you one with the road. The lazered micro profile structure expands over the tire's shoulder and provides outstanding cornering.



Grand Prix 5000 AS TR



TECHNOLOGY



SIZES



FEATURES

Grand Prix 5000 AS TR

BlackChili Compound - Vectran Breaker - LazerGrip - ACT - 2/220 TPI

TR

Article	ETRTO	Dimension	Color/sidewall	g	PSI	EAN	RRP/€
0101910	25-622	700 x 25C	● foldable refl.	300	73-109	4 019238 056754	104,95
0101901	25-622	700 x 25C	● foldable	305	73-109	4 019238 056716	99,95
0101911	28-622	700 x 28C	● foldable refl.	330	73-94	4 019238 056815	104,95
0101902	28-622	700 x 28C	● foldable	340	73-94	4 019238 056792	99,95
0101912	32-622	700 x 32C	● foldable refl.	390	50-73	4 019238 056914	104,95
0101903	32-622	700 x 32C	● foldable	370	50-73	4 019238 056884	99,95
0101913	35-622	700 x 35C	● foldable refl.	435	36-65	4 019238 056990	104,95
0101904	35-622	700 x 35C	● foldable	420	36-65	4 019238 056952	99,95



CONTI KNOWLEDGE

Tubeless Ready:

For initial mounting we recommend to use at least 30 ml of Conti RevoSealant per tire. Then spin the tire (wheel) to spread the Conti RevoSealant inside of the tire and pump to the allowed maximum pressure. Check the pressure before the next ride and adjust to your desired PSI.



This tire is Hookless compatible to its limited max. pressure. Please check wheel instruction and tire packaging for detailed information.



Grand Prix 5000 AS TR



TECHNOLOGY



SIZES



FEATURES

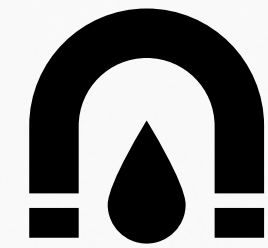

More wet grip

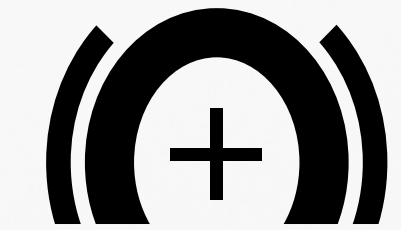

More sidewall protection



More mileage



Higher visibility with
Black-Reflex*

* Does not meet the certification standard ECE-R88. Does not support reflective properties as per StVZO (Germany).

Grand Prix 5000 S TR



TECHNOLOGY



SIZES



FEATURES

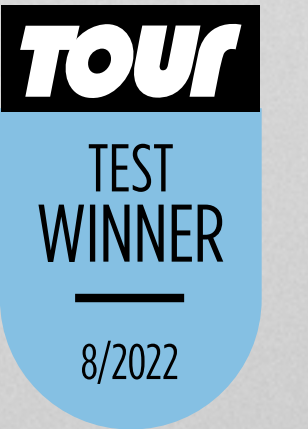



TECHNOLOGY



SIZES



FEATURES

THE NEW ERA IN CYCLING

The proven Grand Prix 5000 S Tubeless Ready: Lighter, faster and with stronger sidewalls. The new standard in road tubeless ready technology. Ride faster, more comfortable and with increased puncture protection. Made to make you better.



With our unique tread compound, we have revolutionized the sport of cycling. With the legendary **BlackChili Compound** we have answered the eternal question of the best balance of grip and rolling resistance for cycling. The latest polymers as well as specially developed carbon black particles and filler materials guarantee unique performance, be it on a road, gravel or a mountain bike, for time trialling or downhill.



The revolutionary approach in cycling. Embedded in the tire construction the **Active Comfort Technology** absorbs vibrations and smoothens your ride.



Vectran is spun from liquid crystal-polymer. This way a thermoplastic, multiple-thread yarn is created. As a comparison: This partially crystalline fabric is more cut-resistant than aramide and its tensile strength is five times higher than that of steel. A Vectran breaker is lighter, more flexible and effective against cuts than a comparable nylon breaker. Without effecting rolling resistance.



Lazer Grip, to make you one with the road. The lazered micro profile structure expands over the tire's shoulder and provides outstanding cornering.



Grand Prix 5000 S TR



TECHNOLOGY



SIZES



FEATURES

Grand Prix 5000 S TR

BlackChili Compound - Vectran Breaker - LazerGrip - ACT - 2/220 TPI

TR

Article	ETRTO	Dimension	Color/sidewall	g	PSI	EAN	RRP/€
0101934	30-584	27.5" 650 x 30B	● foldable	280	56-73	4 019238 063691	87,95
0101935	32-584	27.5" 650 x 32B	● foldable	300	50-73	4 019238 063684	87,95
0101866	25-622	28" 700 x 25C	● foldable	250	73-109	4 019238 054439	87,95
0101873	25-622	28" 700 x 25C	● foldable	255	73-109	4 019238 055559	87,95
0101867	28-622	28" 700 x 28C	● foldable	275	73-94	4 019238 054422	87,95
0101874	28-622	28" 700 x 28C	● foldable	280	73-94	4 019238 055580	87,95
0101868	30-622	28" 700 x 30C	● foldable	295	56-73	4 019238 054415	87,95
0101875	30-622	28" 700 x 30C	● foldable	300	56-73	4 019238 055610	87,95
0101869	32-622	28" 700 x 32C	● foldable	325	50-73	4 019238 054408	87,95
0101876	32-622	28" 700 x 32C	● foldable	325	50-73	4 019238 055641	87,95



CONTI KNOWLEDGE

Tubeless Ready:

For initial mounting we recommend to use at least 30 ml of Conti RevoSealant per tire. Then spin the tire (wheel) to spread the Conti RevoSealant inside of the tire and pump to the allowed maximum pressure. Check the pressure before the next ride and adjust to your desired PSI.



This tire is Hookless compatible to its limited max. pressure. Please check wheel instruction and tire packaging for detailed information.



Grand Prix 5000 S TR



TECHNOLOGY



SIZES



FEATURES

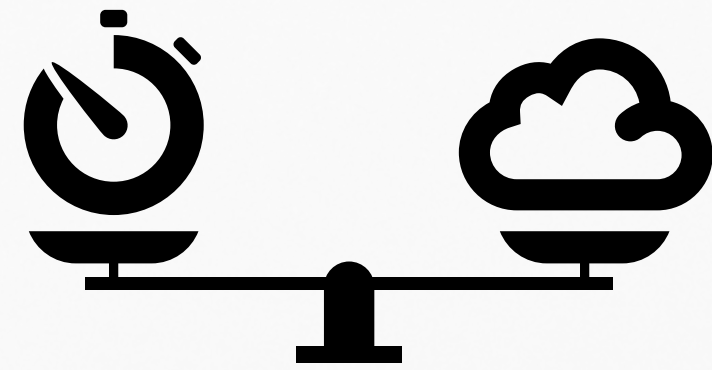

Optimal ratio of speed and comfort

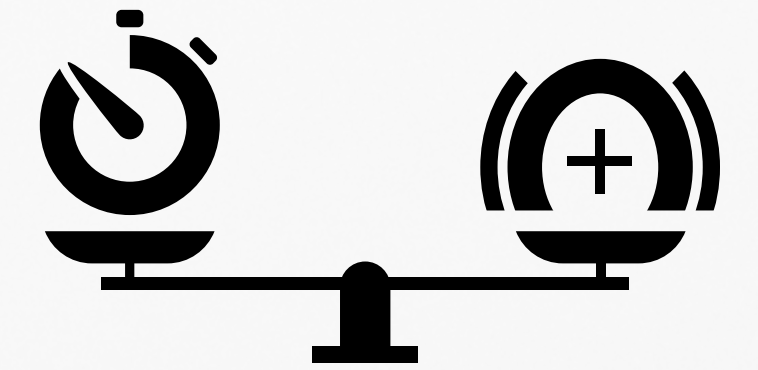

Optimal ratio of speed and puncture protection



Optimal ratio of weight and mileage



Race proven quality



Grand Prix 5000 TT TR



TECHNOLOGY



SIZES



FEATURES



SPECIALIST TIRE FOR RACES AGAINST THE CLOCK

The fastest Grand Prix 5000 tubeless tire for the pursuit of speed, be it in a criterium, time trial or triathlon.



TECHNOLOGY



With our unique tread compound, we have revolutionized the sport of cycling. With the legendary **BlackChili Compound** we have answered the eternal question of the best balance of grip and rolling resistance for cycling. The latest polymers as well as specially developed carbon black particles and filler materials guarantee unique performance, be it on a road, gravel or a mountain bike, for time trialling or downhill.



SIZES



FEATURES



The revolutionary approach in cycling. Embedded in the tire construction the **Active Comfort Technology** absorbs vibrations and smoothens your ride.



Vectran is spun from liquid crystal-polymer. This way a thermoplastic, multiple-thread yarn is created. As a comparison: This partially crystalline fabric is more cut-resistant than aramide and its tensile strength is five times higher than that of steel. A Vectran breaker is lighter, more flexible and effective against cuts than a comparable nylon breaker. Without effecting rolling resistance.



Lazer Grip, to make you one with the road. The lazered micro profile structure expands over the tire's shoulder and provides outstanding cornering.



Grand Prix 5000 TT TR



TECHNOLOGY



SIZES



FEATURES

Grand Prix 5000 TT TR

BlackChili Compound - Vectran Breaker - LazerGrip - ACT - 2/220 TPI

TR

Article	ETRTO	Dimension	Color/sidewall	g	PSI	EAN	RRP/€
0101893	25-622	700 x 25C	● foldable	220	73-109	4 019238 056266	108,95
0101894	28-622	700 x 28C	● foldable	245	73-94	4 019238 056273	108,95



CONTI KNOWLEDGE

Tubeless Ready:

For initial mounting we recommend to use at least 30 ml of Conti RevoSealant per tire. Then spin the tire (wheel) to spread the Conti RevoSealant inside of the tire and pump to the allowed maximum pressure. Check the pressure before the next ride and adjust to your desired PSI.



This tire is Hookless compatible to its limited max. pressure. Please check wheel instruction and tire packaging for detailed information.



Grand Prix 5000 TT TR



TECHNOLOGY



SIZES



FEATURES





Maximum speed



Minimum weight



Vectran Puncture Protection



Race proven quality

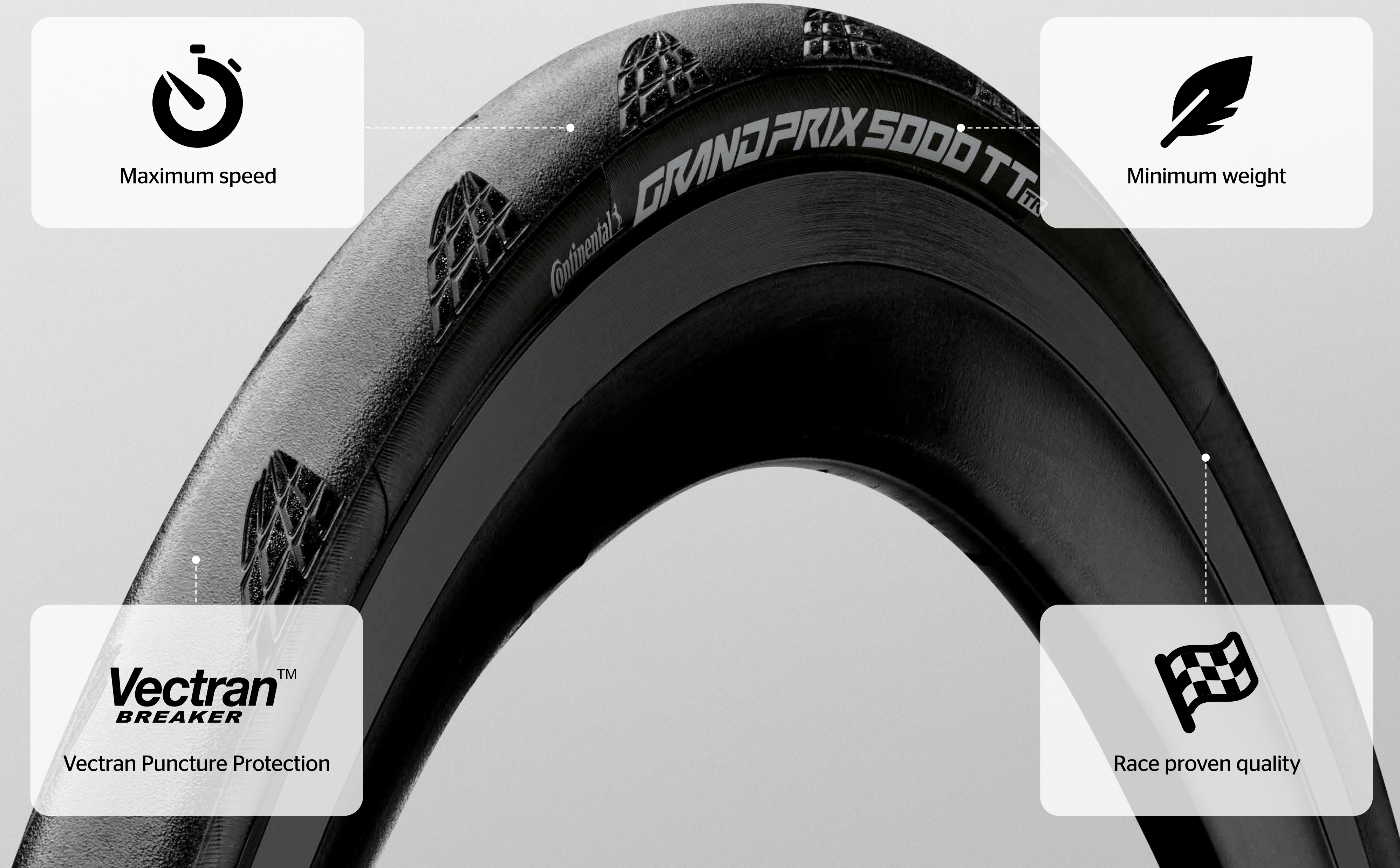

Grand Prix 5000



TECHNOLOGY



SIZES





TECHNOLOGY



SIZES

THE NEW ERA IN CYCLING

Ride faster, more comfortable, and with increased puncture protection. Made to make you better. If your aim is a tubeless approach, we've got you covered as well.



With our unique tread compound, we have revolutionized the sport of cycling. With the legendary **BlackChili Compound** we have answered the eternal question of the best balance of grip and rolling resistance for cycling. The latest polymers as well as specially developed carbon black particles and filler materials guarantee unique performance, be it on a road, gravel or a mountain bike, for time trialling or downhill.



The revolutionary approach in cycling. Embedded in the tire construction the **Active Comfort Technology** absorbs vibrations and smoothens your ride.



Vectran is spun from liquid crystal-polymer. This way a thermoplastic, multiple-thread yarn is created. As a comparison: This partially crystalline fabric is more cut-resistant than aramide and its tensile strength is five times higher than that of steel. A Vectran breaker is lighter, more flexible and effective against cuts than a comparable nylon breaker. Without effecting rolling resistance.



Lazer Grip, to make you one with the road. The lazered micro profile structure expands over the tire's shoulder and provides outstanding cornering.



Grand Prix 5000



TECHNOLOGY



SIZES

Grand Prix 5000

BlackChili Compound - Vectran Breaker - LazerGrip - ACT - 3/330 TPI

Article	ETRTO	Dimension	Color/sidewall	g	PSI	EAN	RRP/€
0101620	25-584	650 x 25B	● foldable	210	95-120	4 019238 007817	74,95
0101622	28-584	650 x 28B	● foldable	230	95-115	4 019238 007831	74,95
0101623	23-622	700 x 23C	● foldable	200	110-120	4 019238 007800	74,95
0101624	25-622	700 x 25C	● foldable	225	95-120	4 019238 007824	74,95
0101947	25-622	700 x 25C	● foldable	260	95-120	4 019238 064711	74,95
0101895	25-622	700 x 25C	● foldable	230	95-120	4 019238 056235	74,95
0101625	28-622	700 x 28C	● foldable	240	95-115	4 019238 007848	74,95
0101948	28-622	700 x 28C	● foldable	290	95-115	4 019238 064728	74,95
0101896	28-622	700 x 28C	● foldable	245	95-115	4 019238 056242	74,95
0101626	32-622	700 x 32C	● foldable	290	85-102	4 019238 007855	74,95
BlackChili Compound - Vectran Breaker - LazerGrip - ACT - 3/330 TPI							E50
0101813	30-622	700 x 30C	● foldable	255	85-102	4 019238 041972	74,95



Faster? Not a problem with approval for e-bikes up to 50 km/h **for the size 30-622!**



Grand Prix



TECHNOLOGY



SIZES



A COMFORTABLE ALL-ROUNDER THAT HAS BEEN WRITTEN INTO CYCLING HISTORY

A reliable all-round tire with solid construction, made for sportive tours in demanding terrain. Made to last for many miles. Available in many sizes.



TECHNOLOGY



With our unique tread compound, we have revolutionized the sport of cycling. With the legendary **BlackChili Compound** we have answered the eternal question of the best balance of grip and rolling resistance for cycling. The latest polymers as well as specially developed carbon black particles and filler materials guarantee unique performance, be it on a road, gravel or a mountain bike, for time trialling or downhill.



With **PolyX Breaker™** car expertise comes to the bicycle tire sector. Polyester has been used successfully for years in car tires and has proved extremely effective. The extremely resistant polyester fibre is woven tightly crosswise. A very high fabric density is achieved which makes the breaker resistant not only to foreign bodies, but especially to punctures. The rolling resistance is not affected by this breaker.



SIZES



Grand Prix

Grand Prix

BlackChili Compound - PolyX Breaker - 3/180 TPI

Article	ETRTO	Dimension	Color/sidewall	g	PSI	EAN	RRP/€
0100149	28-559	26 x 1½	● foldable	245	95-115	4 019238 393873	44,95
0100506	23-622	700 x 23C	● foldable	230	110-120	4 019238 564617	44,95
0100637	25-622	700 x 25C	● foldable	230	110-120	4 019238 581409	44,95
0101109	28-622	700 x 28C	● foldable	270	95-115	4 019238 674590	44,95



TECHNOLOGY



SIZES



ROAD

Grand Prix 4-Season



TECHNOLOGY



SIZES



THE ALL-YEAR-ROUND TIRE AND A RELIABLE COMPANION FOR THOSE HIGH MILEAGE ROAD CYCLISTS

Reliable companion for training rides and in competition, come rain or shine. The tire with a superior durability ready for any season.



TECHNOLOGY

Vectran[™]
BREAKER

Vectran is spun from liquid crystal-polymer. This way a thermoplastic, multiple-thread yarn is created. As a comparison: This partially crystalline fabric is more cut-resistant than aramide and its tensile strength is five times higher than that of steel. A Vectran breaker is lighter, more flexible and effective against cuts than a comparable nylon breaker. Without effecting rolling resistance.



SIZES

 **DuraSkin**[®]

Tires with **DuraSkin**[®] sidewall protection can take a beating as they are designed for the most adverse conditions. In rough terrain on a cyclocross or a gravel bike, on commuter bikes where tires scrape along curbs, on touring bikes as they cross continents encountering many different road qualities and on the race circuit where they prove themselves in endurance events such as the Paris-Roubaix. The high-quality polyamide fabric reliably protects the wall of the tire. Tires with DuraSkin[®] can be identified by the characteristic brown mesh sidewall.



Grand Prix 4-Season



TECHNOLOGY



SIZES

Grand Prix 4-Season

Double Vectran Breaker - 3/330 TPI

Article	ETRTO	Dimension	Color/sidewall	g	PSI	EAN	RRP/€
0100173	23-622	700 x 23C	● foldable	235	110-120	4 019238 409093	72,95
0100175	25-622	700 x 25C	● foldable	230	95-120	4 019238 409116	72,95
0101105	28-622	700 x 28C	● foldable	295	95-115	4 019238 674620	72,95
0101095	32-622	700 x 32C	● foldable	340	85-102	4 019238 668131	72,95

Vectran™ BREAKER **DuraSkin®**



Grand Prix Urban



TECHNOLOGY



SIZES



„COFFEE”

THE STATEMENT TIRE FOR THE CITY

Combines a modern tread pattern design with the latest technology. Built with a tuned race construction while damping for comfort – a matching mix for the urban ride. Its black reflective stripe* blends perfectly with the sidewall.



TECHNOLOGY



With our unique tread compound, we have revolutionized the sport of cycling. With the legendary **BlackChili Compound** we have answered the eternal question of the best balance of grip and rolling resistance for cycling. The latest polymers as well as specially developed carbon black particles and filler materials guarantee unique performance, be it on a road, gravel or a mountain bike, for time trialling or downhill.



With **PolyX Breaker™** car expertise comes to the bicycle tire sector. Polyester has been used successfully for years in car tires and has proved extremely effective. The extremely resistant polyester fibre is woven tightly crosswise. A very high fabric density is achieved which makes the breaker resistant not only to foreign bodies, but especially to punctures. The rolling resistance is not affected by this breaker.



SIZES



*Does not meet the certification standard ECE-R88. Does not support reflective properties as per StVZO (Germany).

Grand Prix Urban

Grand Prix Urban

BlackChili Compound - PolyX Breaker - 3/180 TPI

Article	ETRTO	Dimension	Color/sidewall	g	PSI	EAN	RRP/€
0101575	35-622	28 x 1 $\frac{3}{8}$ x 15/8	● foldable	345	65-85	4 019238 002447	52,95
0101673	35-622	28 x 1 $\frac{3}{8}$ x 15/8	● foldable	335	65-85	4 019238 022940	52,95



TECHNOLOGY



SIZES



Developed together with

schindelbauer

Ultra Sport III



TECHNOLOGY



SIZES



MODERN TIRE FOR THOSE NEW TO ROAD CYCLING

Completely renewed, sporting a dynamic tread pattern design. Matches with a race bike, as well as a classic city road bike. Available in a wide range of dimensions and colors.



TECHNOLOGY



PureGrip Compound is derived from an activated Silica compound and is a good example of how we integrate customer feedback continuously into our research and development. This mixture technology fits in perfectly alongside the BlackChili Compound. The name PureGrip does exactly what it says; exceptionally good grip and durability are the distinguishing features of this compound. Engineered with PureGrip in our Performance products in our road and mountain bike ranges.



Suitable for E-Bikes: For our E-Bike tire we fall back on over 100 years' experience with moped and motorcycle tires. Those tires marked are also certified for S-Pedelecs. With their high quality structure, puncture protection is high and the rolling resistance is low offering protection from premature wear brought about by the additional driving force.



SIZES



Ultra Sport III



TECHNOLOGY



SIZES

Ultra Sport III

PureGrip Compound - 3/180 TPI

E25

Article	ETRTO	Dimension	Color/sidewall	g	PSI	EAN	RRP/€
0150449	23-622	700 x 23C	● foldable	245	110-125	4 019238 026641	28,95
0150457	25-622	700 x 25C	● foldable	265	95-125	4 019238 026849	28,95
0150466	28-622	700 x 28C	● foldable	290	80-115	4 019238 026917	28,95
0150680	28-622	700 x 28C	● foldable	285	80-115	4 019238 064629	28,95
0150470	32-622	700 x 32C	● Wire	410	65-100	4 019238 026924	22,95



Gator Hardshell



TECHNOLOGY



SIZES





TECHNOLOGY

GO HARDSHELL OR GO HOME

Ideal when it comes to extremely long service life, for the next tour or the commute. Made for rough surfaces and rugged tarmac. With DuraSkin® sidewall reinforcement.



Puncture protection and mileage are the strengths of **Hardshell-Protection**. A wider PolyX Breaker™, the specialist against punctures, under the tread centre and shoulders provides for great reliability. The three-ply - each layer with 60 TPI - carcass covers the entire tire and makes it a real bastion against urban detritus. The outer sidewalls of the tire are reinforced with DuraSkin® fabric providing even more reliability due to the casing being so well protected. Hardshell tires are the puncture-resistant flagship amongst racing tires.



Tires with **DuraSkin®** sidewall protection can take a beating as they are designed for the most adverse conditions. In rough terrain on a cyclocross or a gravel bike, on commuter bikes where tires scrape along curbs, on touring bikes as they cross continents encountering many different road qualities and on the race circuit where they prove themselves in endurance events such as the Paris-Roubaix. The high-quality polyamide fabric reliably protects the wall of the tire. Tires with DuraSkin® can be identified by the characteristic brown mesh sidewall*.

**DuraSkin® comes in restrained black with our Black Edition*



SIZES



Gator Hardshell



TECHNOLOGY



SIZES

Gator Hardshell

Hardshell - 3/180 TPI

Article	ETRTO	Dimension	Color/sidewall	g	PSI	EAN	RRP/€
0100311	23-622	700 x 23C	● foldable	265	110-120	4 019238 466379	59,95
0100310	23-622	700 x 23C	● Wire	335	110-120	4 019238 466362	54,95
0100313	25-622	700 x 25C	● foldable	270	95-120	4 019238 466409	59,95
0100312	25-622	700 x 25C	● Wire	340	95-120	4 019238 466393	54,95
0100639	28-622	700 x 28C	● foldable	330	95-115	4 019238 581423	59,95
0100314	28-622	700 x 28C	● Wire	400	95-115	4 019238 466423	54,95
0100640	32-622	700 x 32C	● foldable	370	85-102	4 019238 581416	59,95
0100435	32-622	700 x 32C	● Wire	440	85-102	4 019238 521542	54,95
0100315	32-630	27 x 1¼	● Wire	440	85-102	4 019238 466430	54,95



Gator Hardshell Black Edition

Hardshell - 3/180 TPI

Article	ETRTO	Dimension	Color/sidewall	g	PSI	EAN	RRP/€
0101724	23-622	700 x 23C	● foldable	265	110-120	4 019238 030846	64,95
0101725	25-622	700 x 25C	● foldable	270	95-120	4 019238 030839	64,95
0101726	28-622	700 x 28C	● foldable	330	95-115	4 019238 030822	64,95
0101727	32-622	700 x 32C	● foldable	370	85-102	4 019238 030815	64,95



Gatorskin



TECHNOLOGY



SIZES





TECHNOLOGY



SIZES



RIDE HOW AND WHERE YOU WANT: THE GLOBAL NUMBER ONE FOR FIXED, MESSENGER AND URBAN CYCLISTS

The right tire when it comes to tough conditions. The right choice for a strong performance in the urban field and on tour.



With **PolyX Breaker™** car expertise comes to the bicycle tire sector. Polyester has been used successfully for years in car tires and has proved extremely effective. The extremely resistant polyester fibre is woven tightly crosswise. A very high fabric density is achieved which makes the breaker resistant not only to foreign bodies, but especially to punctures. The rolling resistance is not affected by this breaker.



Tires with **DuraSkin®** sidewall protection can take a beating as they are designed for the most adverse conditions. In rough terrain on a cyclocross or a gravel bike, on commuter bikes where tires scrape along curbs, on touring bikes as they cross continents encountering many different road qualities and on the race circuit where they prove themselves in endurance events such as the Paris-Roubaix. The high-quality polyamide fabric reliably protects the wall of the tire. Tires with DuraSkin® can be identified by the characteristic brown mesh sidewall*.

**DuraSkin® comes in restrained black with our Black Edition*

Gatorskin



TECHNOLOGY



SIZES

Gatorskin

PolyX Breaker - 3/180 TPI

Article	ETRTO	Dimension	Color/sidewall	g	PSI	EAN	RRP/€
0118365	28-559	26 x 1½	● Wire	320	95-120	4 019238 334708	46,95
0118364	23-571	650 x 23C	● Wire	275	110-120	4 019238 334692	46,95
0118538	23-622	700 x 23C	● foldable	230	110-120	4 019238 334647	51,95
0118537	23-622	700 x 23C	● Wire	300	110-120	4 019238 334630	46,95
0100084	25-622	700 x 25C	● foldable	245	95-120	4 019238 371390	51,95
0118539	25-622	700 x 25C	● Wire	310	95-120	4 019238 334661	46,95
0100641	28-622	700 x 28C	● foldable	280	95-115	4 019238 581430	51,95
0121228	28-622	700 x 28C	● Wire	355	95-115	4 019238 334678	46,95
0100642	32-622	700 x 32C	● foldable	350	85-102	4 019238 581447	51,95
0100437	32-622	700 x 32C	● Wire	415	85-102	4 019238 521573	46,95
0122300	32-630	27 x 1¼	● Wire	420	85-102	4 019238 334685	46,95



Gatorskin Black Edition

PolyX Breaker - 3/180 TPI

Article	ETRTO	Dimension	Color/sidewall	g	PSI	EAN	RRP/€
0101728	23-622	700 x 23C	● foldable	230	110-120	4 019238 030877	56,95
0101729	25-622	700 x 25C	● foldable	245	95-120	4 019238 030860	56,95
0101730	28-622	700 x 28C	● foldable	280	95-115	4 019238 030884	56,95
0101731	32-622	700 x 32C	● foldable	350	85-102	4 019238 030853	56,95



Grand Sport Race



TECHNOLOGY



SIZES



PROVEN RACING TIRE CONTOUR FOR RESPONSIVE HANDLING AND SECURE GRIP

Performance in touring and competition. This all-rounder is ready for every challenge, even the biggest ones.



TECHNOLOGY



PureGrip Compound is derived from an activated Silica compound and is a good example of how we integrate customer feedback continuously into our research and development. This mixture technology fits in perfectly alongside the BlackChili Compound. The name PureGrip does exactly what it says; exceptionally good grip and durability are the distinguishing features of this compound. Engineered with PureGrip in our Performance products in our road and mountain bike ranges.



The **Nytech Breaker** is based on the technology of our Safety-System puncture protection. Made of nylon fibre and similar to Kevlar, it reliably protects against punctures and cuts. It also has particularly low rolling resistance and reduced weight, perfect for our performance range of road tires.



SIZES



Grand Sport Race



TECHNOLOGY



SIZES

Grand Sport Race

PureGrip Compound - NyTech Breaker - 3/180 TPI

Article	ETRTO	Dimension	Color/sidewall	g	PSI	EAN	RRP/€
0150001	23-622	700 X 23C	● foldable	245	110-120	4 019238 586565	37,95
0150027	25-622	700 X 25C	● foldable	270	95-120	4 019238 587319	37,95
0150025	25-622	700 X 25C	● Wire	345	95-120	4 019238 587333	32,95
0150118	28-622	700 X 28C	● foldable	335	80-115	4 019238 621105	37,95
0150116	28-622	700 X 28C	● Wire	410	80-115	4 019238 621129	32,95
0150624	28-622	700 X 28C	● foldable	305	80-115	4 019238 062458	37,95
0150141	32-622	700 X 32C	● foldable	400	65-102	4 019238 656602	37,95
0150164	32-622	700 X 32C	● Wire	470	65-102	4 019238 671018	32,95



Hometrainer II



TECHNOLOGY



SIZES



THE KM ACCUMULATOR ON THE ROLLERS

Developed for the essential basic training at home. Particularly smooth running. The durable cold-running compound stops heat build up.

! Suitable for training on rollers/home trainers only.



TECHNOLOGY



SIZES

Hometrainer II

Foldable - 3/180 TPI

Article	ETRTO	Dimension	Color/sidewall	g	PSI	EAN	RRP/€
0100648	47-559	26 x 1.75	● foldable	365	45-65	4 019238 581454	39,95
0101275	50-584	27.5 x 2.00	● foldable	400	45-65	4 019238 730456	39,95
0100647	23-622	700 x 23C	● foldable	205	110-120	4 019238 581461	39,95
0100649	32-622	700 x 32C	● foldable	275	85-102	4 019238 581478	39,95



Xynotal

Kryptotal

Fr Re

Argotal

Hydrotal

Mountain King

Cross King

Race King

Ruban | eRuban

Double Fighter III



MTB

Xynotal



TECHNOLOGY



SIZES



CONTROL OVER ROCK AND HARDBACK TERRAIN

With low rolling resistance and contact edges for improved traction and braking, you can enjoy a fast gravity ride with the confidence of continuous grip when you need it most.



TECHNOLOGY

TERRAIN



Perfect for **hardpack**, rocky surfaces

CASING



Downhill: Most durable and reinforced carcass construction in gravity line up



Enduro: Durable single ply carcass construction with Apex to prevent snakebites



Trail: Comparable performance to the Enduro casing tailored for trail use cases

COMPOUND

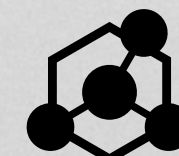

SuperSoft: Especially for Downhill and Enduro use cases where the main focus is descending. Tires equipped with this compound are for riders with a 100% focus on grip, traction, control.

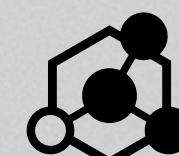

Soft: The balance of grip and rolling resistance for gravity focussed use cases. High level of grip with a reasonable rolling resistance.

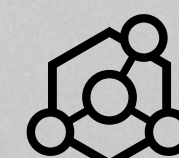

Endurance: Compound with balanced properties on grip and endurance. With the endurance compound a high durability in combination with good rolling resistance and grip is achieved.





TECHNOLOGY



SIZES

Xynotal

Downhill SuperSoft - 6/660 TPI

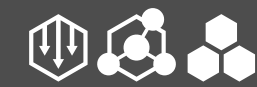
**E25 TR**

Article	ETRTO	Dimension	Color/sidewall	g	PSI	EAN	RRP/€
0101931	60-584	27.5 x 2.40	● foldable	1255	36-51	4 019238 063370	89,95
0101932	60-622	29 x 2.40	● foldable	1335	36-51	4 019238 063356	89,95
Downhill Soft - 6/660 TPI							
0101995	60-584	27.5 x 2.40	● foldable	1260	36-51	4 019238 080742	84,95
0101996	60-622	29 x 2.40	● foldable	1335	36-51	4 019238 080735	84,95
Enduro Soft - 3/330 TPI							
0150644	60-584	27.5 x 2.40	● foldable	1115	36-51	4 019238 063295	74,95
0150645	60-622	29 x 2.40	● foldable	1180	36-51	4 019238 063288	74,95
Trail Endurance - 3/180 TPI							
0150646	60-584	27.5 x 2.40	● foldable	1000	36-51	4 019238 063257	62,95
0150647	60-622	29 x 2.40	● foldable	1060	36-51	4 019238 063240	62,95



CONTI KNOWLEDGE

Tubeless Ready:

For initial mounting we recommend to use at least 30 ml of Conti RevoSealant per tire. Then spin the tire (wheel) to spread the Conti RevoSealant inside of the tire and pump to the allowed maximum pressure. Check the pressure before the next ride and adjust to your desired PSI.



This tire is Hookless compatible to its limited max. pressure. Please check wheel instruction and tire packaging for detailed information.



Kryptotal ^{Fr}

Kryptotal ^{Re}



TECHNOLOGY



SIZES Fr



SIZES Re





TECHNOLOGY



SIZES Fr



SIZES Re



SPECIALISTS FOR MIXED TERRAIN

Optimized for front and rear wheels, this all-round tire achieves the perfect balance of stability, traction and optimal rolling resistance. Ideal for mixed terrain, they'll allow you to push your limits during trail, enduro and downhill riding.

TERRAIN



Ideal for **mixed** terrain conditions

CASING



Downhill: Most durable and reinforced carcass construction in gravity line up



Enduro: Durable single ply carcass construction with Apex to prevent snakebites



Trail: Comparable performance to the Enduro casing tailored for trail use cases

COMPOUND

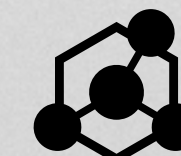

SuperSoft: Especially for Downhill and Enduro use cases where the main focus is descending. Tires equipped with this compound are for riders with a 100% focus on grip, traction, control.

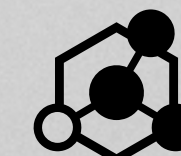

Soft: The balance of grip and rolling resistance for gravity focussed use cases. High level of grip with a reasonable rolling resistance.

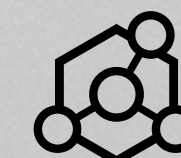

Endurance: Compound with balanced properties on grip and endurance. With the endurance compound a high durability in combination with good rolling resistance and grip is achieved.



TECHNOLOGY



SIZES Fr



SIZES Re

Kryptotal Fr

Downhill SuperSoft - 6/660 TPI

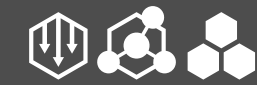
**E25 TR**

Article	ETRTO	Dimension	Color/sidewall	g	PSI	EAN	RRP/€
0101956	60-584	27.5 x 2.40	● foldable	1255	36-51	4 019238 070514	89,95
0101957	60-622	29 x 2.40	● foldable	1335	36-51	4 019238 070491	89,95
Enduro Soft - 3/330 TPI							
0150705	60-559	26 x 2.40	● foldable	1050	36-51	4 019238 089752	69,95
0150694	60-584	27.5 x 2.40	● foldable	1115	36-51	4 019238 074116	74,95
0150696	60-622	29 x 2.40	● foldable	1180	36-51	4 019238 074079	74,95
Trail Endurance - 3/180 TPI							
NEW 0150709	60-507	24 x 2.40	● foldable	840	36-51	4 019238 089776	62,95
0150695	60-584	27.5 x 2.40	● foldable	1000	36-51	4 019238 074093	62,95
0150697	60-622	29 x 2.40	● foldable	1060	36-51	4 019238 074055	62,95



CONTI KNOWLEDGE

Tubeless Ready:

For initial mounting we recommend to use at least 30 ml of Conti RevoSealant per tire. Then spin the tire (wheel) to spread the Conti RevoSealant inside of the tire and pump to the allowed maximum pressure. Check the pressure before the next ride and adjust to your desired PSI.



This tire is Hookless compatible to its limited max. pressure. Please check wheel instruction and tire packaging for detailed information.





TECHNOLOGY



SIZES Fr



SIZES Re

Kryptotal Re

Downhill SuperSoft - 6/660 TPI

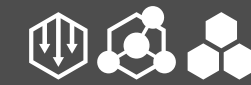
**E25****TR**

Article	ETRTO	Dimension	Color/sidewall	g	PSI	EAN	RRP/€
0101928	60-584	27.5 x 2.40	● foldable	1255	36-51	4 019238 063219	89,95
0101930	60-622	29 x 2.40	● foldable	1335	36-51	4 019238 063196	89,95

Downhill Soft - 6/660 TPI

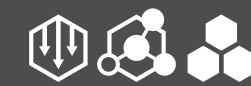

0101991	60-584	27.5 x 2.40	● foldable	1260	36-51	4 019238 080780	84,95
0101992	60-622	29 x 2.40	● foldable	1335	36-51	4 019238 080773	84,95

Enduro Soft - 3/330 TPI

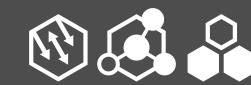

0150707	60-559	26 x 2.40	● foldable	1050	36-51	4 019238 089738	69,95
0150632	60-584	27.5 x 2.40	● foldable	1115	36-51	4 019238 063134	74,95
0150634	60-622	29 x 2.40	● foldable	1180	36-51	4 019238 063127	74,95
0150635	65-584	27.5 x 2.60	● foldable	1265	29-44	4 019238 063097	79,95
0150636	65-622	29 x 2.60	● foldable	1345	29-44	4 019238 063080	79,95

Trail Endurance - 3/180 TPI

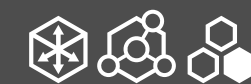

NEW 0150708	60-507	24 x 2.40	● foldable	840	36-51	4 019238 089790	62,95
0150637	60-584	27.5 x 2.40	● foldable	1000	36-51	4 019238 063059	62,95
0150638	60-622	29 x 2.40	● foldable	1060	36-51	4 019238 063042	62,95
0150639	65-584	27.5 x 2.60	● foldable	1155	29-44	4 019238 063011	67,95
0150640	65-622	29 x 2.60	● foldable	1240	29-44	4 019238 063004	67,95



CONTI KNOWLEDGE

Tubeless Ready:

For initial mounting we recommend to use at least 30 ml of Conti RevoSealant per tire. Then spin the tire (wheel) to spread the Conti RevoSealant inside of the tire and pump to the allowed maximum pressure. Check the pressure before the next ride and adjust to your desired PSI.



This tire is Hookless compatible to its limited max. pressure. Please check wheel instruction and tire packaging for detailed information.



Argotal



TECHNOLOGY



SIZES



ENGINEERED FOR LOOSE CONDITIONS

The ideal tire for loose terrain given its incredible cornering stability and enhanced side-grip. The open tread pattern allows for self-cleaning so you can push your limits while riding through dust and loam.



TECHNOLOGY

TERRAIN



Ideal for **loose** terrain

CASING



Downhill: Most durable and reinforced carcass construction in gravity line up



Enduro: Durable single ply carcass construction with Apex to prevent snakebites



Trail: Comparable performance to the Enduro casing tailored for trail use cases

COMPOUND

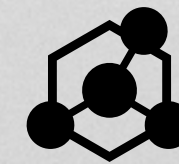

SuperSoft: Especially for Downhill and Enduro use cases where the main focus is descending. Tires equipped with this compound are for riders with a 100% focus on grip, traction, control.

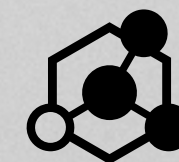

Soft: The balance of grip and rolling resistance for gravity focussed use cases. High level of grip with a reasonable rolling resistance.

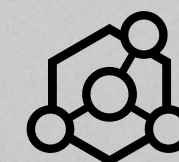

Endurance: Compound with balanced properties on grip and endurance. With the endurance compound a high durability in combination with good rolling resistance and grip is achieved.



SIZES





TECHNOLOGY



SIZES

Argotal

Downhill SuperSoft - 6/660 TPI

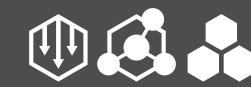
**E25 TR**

Article	ETRTO	Dimension	Color/sidewall	g	PSI	EAN	RRP/€
0101951	60-584	27.5 x 2.40	● foldable	1255	36-51	4 019238 067866	89,95
0101953	60-622	29 x 2.40	● foldable	1335	36-51	4 019238 067842	89,95
Downhill Soft - 6/660 TPI							
0101999	60-584	27.5 x 2.40	● foldable	1260	36-51	4 019238 080704	84,95
0102000	60-622	29 x 2.40	● foldable	1335	36-51	4 019238 080698	84,95
Enduro Soft - 3/330 TPI							
0150684	60-584	27.5 x 2.40	● foldable	1115	36-51	4 019238 068016	74,95
0150686	60-622	29 x 2.40	● foldable	1180	36-51	4 019238 068078	74,95
0150685	65-584	27.5 x 2.60	● foldable	1265	29-44	4 019238 067910	79,95
0150688	65-622	29 x 2.60	● foldable	1345	29-44	4 019238 067958	79,95
Trail Endurance - 3/180 TPI							
0150689	60-584	27.5 x 2.40	● foldable	1000	36-51	4 019238 067972	62,95
0150691	60-622	29 x 2.40	● foldable	1060	36-51	4 019238 068030	62,95
0150690	65-584	27.5 x 2.40	● foldable	1155	29-44	4 019238 067897	67,95
0150692	65-622	29 x 2.60	● foldable	1240	29-44	4 019238 067934	67,95



CONTI KNOWLEDGE

Tubeless Ready:

For initial mounting we recommend to use at least 30 ml of Conti RevoSealant per tire. Then spin the tire (wheel) to spread the Conti RevoSealant inside of the tire and pump to the allowed maximum pressure. Check the pressure before the next ride and adjust to your desired PSI.



This tire is Hookless compatible to its limited max. pressure. Please check wheel instruction and tire packaging for detailed information.



Hydrotal



TECHNOLOGY



SIZES





TECHNOLOGY



SIZES

DOMINATES THE WET AND MUD

Our specialist tire for downhill riding which also provides a super-soft compound option for racing. Hydrotal balances grip and rolling resistance and features a self-cleaning tread to ensure consistent grip when you're shredding through muddy, slippery conditions.

TERRAIN



Specialist for **mud** terrain

CASING



Downhill: Most durable and reinforced carcass construction in gravity line up

COMPOUND

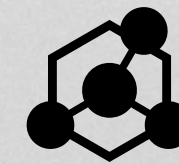

SuperSoft: Especially for Downhill and Enduro use cases where the main focus is descending. Tires equipped with this compound are for riders with a 100% focus on grip, traction, control.



Hydrotal

Hydrotal

Downhill SuperSoft - 6/660 TPI

**E25** **TR**

Article	ETRTO	Dimension	Color/sidewall	g	PSI	EAN	RRP/€
0101954	60-584	27.5 x 2.40	● foldable	1255	36-51	4 019238 067880	89,95
0101955	60-622	29 x 2.40	● foldable	1335	36-51	4 019238 067873	89,95



CONTI KNOWLEDGE

Tubeless Ready:

For initial mounting we recommend to use at least 30 ml of Conti RevoSealant per tire. Then spin the tire (wheel) to spread the Conti RevoSealant inside of the tire and pump to the allowed maximum pressure. Check the pressure before the next ride and adjust to your desired PSI.



This tire is Hookless compatible to its limited max. pressure. Please check wheel instruction and tire packaging for detailed information.



TECHNOLOGY



SIZES



Mountain King



TECHNOLOGY



SIZES



FOR SAFE OFF-ROADING

The perfect trail ride companion - not stingy on grip, ideal for full-suspension trail bikes. The snappy central knobs and grippy outer knobs means it offers maximum grip.



TECHNOLOGY



With our unique tread compound, we have revolutionized the sport of cycling. With the legendary **BlackChili Compound** we have answered the eternal question of the best balance of grip and rolling resistance for cycling. The latest polymers as well as specially developed carbon black particles and filler materials guarantee unique performance, be it on a road, gravel or a mountain bike, for time trialling or downhill.



The extra all-round puncture protection layer renders the casings extremely durable and resistant to damage or penetration from foreign elements. Treads and sidewalls are equally protected, and are 25% lighter and offer 30% more puncture protection than their predecessors protected by DuraSkin®. Rolling resistance and absorption has also significantly improved. The new Revolution Tubeless Ready Bead improves the installation of Tubeless Ready Tires. For tubeless sealing we recommend the use of Continental RevoSealant.



PureGrip Compound is derived from an activated Silica compound and is a good example of how we integrate customer feedback continuously into our research and development. This mixture technology fits in perfectly alongside the BlackChili Compound. The name PureGrip does exactly what it says; exceptionally good grip and durability are the distinguishing features of this compound. Engineered with PureGrip in our Performance products in our road and mountain bike ranges.



The **ShieldWall System** combines the optimum combination of high puncture protection and the low rolling resistance with low weight. This is made possible by an additional, all-round puncture protection layer, which consists of a finely woven cross fabric. This gives the tire a high resistance to punctures and damage. Despite its additional ply, the tire has a very good damping property and a high degree of flexibility to adapt perfectly to the ground. The revolutionary tubeless ready bead allows easy and uncomplicated mounting of the tire. For best results in sealing and in use, we recommend the use of the new Continental RevoSealant sealant.



SIZES

Mountain King



TECHNOLOGY



SIZES

Mountain King

BlackChili Compound - ProTecton - 3/180 TPI

E25 TR

Article	ETRTO	Dimension	Color/sidewall	g	PSI	EAN	RRP/€
0101479	58-559	26 x 2.30	● foldable	610	40-54	4 019238 798425	69,95
0101461	58-584	27.5 x 2.30	● foldable	640	40-54	4 019238 798371	69,95
0101583	65-584	27.5 x 2.60	● foldable	790	29-44	4 019238 003543	67,95
0101582	70-584	27.5 x 2.80	● foldable	830	25-40	4 019238 003550	67,95
0101469	58-622	29 x 2.30	● foldable	680	40-54	4 019238 798432	69,95

PureGrip Compound - ShieldWall System - 3/180 TPI

E25 TR

0150301	58-559	26 x 2.30	● foldable	765	40-54	4 019238 798333	39,95
0150289	58-584	27.5 x 2.30	● foldable	770	40-54	4 019238 798302	39,95
0150335	65-584	27.5 x 2.60	● foldable	930	29-44	4 019238 003598	44,95
0150334	70-584	27.5 x 2.80	● foldable	1010	25-40	4 019238 003628	44,95
0150294	58-622	29 x 2.30	● foldable	915	40-54	4 019238 798340	39,95

Wire - 3/180 TPI

E25

0150424	58-559	26 x 2.30	● Wire	710	40-54	4 019238 026207	24,95
0150425	58-584	27.5 x 2.30	● Wire	765	40-54	4 019238 026191	24,95
0150427	58-622	29 x 2.30	● Wire	810	40-54	4 019238 026177	24,95

CONTI KNOWLEDGE

Tubeless Ready:

For initial mounting we recommend to use at least 30 ml of Conti RevoSealant per tire. Then spin the tire (wheel) to spread the Conti RevoSealant inside of the tire and pump to the allowed maximum pressure. Check the pressure before the next ride and adjust to your desired PSI.



Cross King



TECHNOLOGY



SIZES PROTECTION



SIZES SHIELDWALL



SIZES WIRE



„BERNSTEIN”

THE ALL-ROUNDER

Versatile competition and trail tire, sure footed in turns and comfortable. Good grip and available with various technologies. Smoothly rolling tire that adapts to any terrain with its special tread.



TECHNOLOGY



SIZES PROTECTION



SIZES SHIELDWALL



SIZES WIRE



With our unique tread compound, we have revolutionized the sport of cycling. With the legendary **BlackChili Compound** we have answered the eternal question of the best balance of grip and rolling resistance for cycling. The latest polymers as well as specially developed carbon black particles and filler materials guarantee unique performance, be it on a road, gravel or a mountain bike, for time trialling or downhill.



The extra all-round puncture protection layer renders the casings extremely durable and resistant to damage or penetration from foreign elements. Treads and sidewalls are equally protected, and are 25% lighter and offer 30% more puncture protection than their predecessors protected by DuraSkin®. Rolling resistance and absorption has also significantly improved. The new Revolution Tubeless Ready Bead improves the installation of Tubeless Ready Tires. For tubeless sealing we recommend the use of Continental RevoSealant.



PureGrip Compound is derived from an activated Silica compound and is a good example of how we integrate customer feedback continuously into our research and development. This mixture technology fits in perfectly alongside the BlackChili Compound. The name PureGrip does exactly what it says; exceptionally good grip and durability are the distinguishing features of this compound. Engineered with PureGrip in our Performance products in our road and mountain bike ranges.



The **ShieldWall System** combines the optimum combination of high puncture protection and the low rolling resistance with low weight. This is made possible by an additional, all-round puncture protection layer, which consists of a finely woven cross fabric. This gives the tire a high resistance to punctures and damage. Despite its additional ply, the tire has a very good damping property and a high degree of flexibility to adapt perfectly to the ground. The revolutionary tubeless ready bead allows easy and uncomplicated mounting of the tire. For best results in sealing and in use, we recommend the use of the new Continental RevoSealant sealant.



Cross King



TECHNOLOGY



SIZES PROTECTION



SIZES SHIELDWALL



SIZES WIRE

Cross King

BlackChili Compound - ProTecton - 3/180 TPI

E25 TR

Article	ETRTO	Dimension	Color/sidewall	g	PSI	EAN	RRP/€
0101964	55-559	26 x 2.20	● foldable	610	44-58	4 019238 071481	64,95
0101483	55-559	26 x 2.20	● foldable	570	44-58	4 019238 798036	64,95
0101481	58-559	26 x 2.30	● foldable	610	40-54	4 019238 798401	64,95
0101965	55-584	27.5 x 2.20	● foldable	640	44-58	4 019238 071474	64,95
0101465	55-584	27.5 x 2.20	● foldable	595	44-58	4 019238 798050	64,95
0101463	58-584	27.5 x 2.30	● foldable	640	40-54	4 019238 798364	64,95
0101384	65-584	27.5 x 2.60	● foldable	790	29-44	4 019238 773606	69,95
0101385	70-584	27.5 x 2.80	● foldable	830	25-40	4 019238 773620	69,95
0101966	55-622	29 x 2.20	● foldable	675	44-58	4 019238 071467	64,95
0101471	55-622	29 x 2.20	● foldable	635	44-58	4 019238 798043	64,95
0101475	58-622	29 x 2.30	● foldable	680	40-54	4 019238 798418	64,95



CONTI KNOWLEDGE

Tubeless Ready:

For initial mounting we recommend to use at least 30 ml of Conti RevoSealant per tire. Then spin the tire (wheel) to spread the Conti RevoSealant inside of the tire and pump to the allowed maximum pressure. Check the pressure before the next ride and adjust to your desired PSI.



Cross King



TECHNOLOGY



SIZES PROTECTION



SIZES SHIELDWALL



SIZES WIRE

Cross King

PureGrip Compound - ShieldWall System - 3/180 TPI

E25 TR

Article	ETRTO	Dimension	Color/sidewall	g	PSI	EAN	RRP/€
0150310	50-559	26 x 2.00	● foldable	585	51-65	4 019238 797459	39,95
0150303	55-559	26 x 2.20	● foldable	670	45-58	4 019238 797480	39,95
0150302	58-559	26 x 2.30	● foldable	710	40-54	4 019238 798319	39,95
0150308	50-584	27.5 x 2.00	● foldable	665	51-65	4 019238 797466	39,95
0150291	55-584	27.5 x 2.20	● foldable	740	45-58	4 019238 797503	39,95
0150290	58-584	27.5 x 2.30	● foldable	775	40-54	4 019238 798296	39,95
0150337	65-584	27.5 x 2.60	● foldable	920	29-44	4 019238 003581	44,95
0150336	70-584	27.5 x 2.80	● foldable	1040	25-40	4 019238 003611	44,95
0150306	50-622	29 x 2.00	● foldable	705	51-65	4 019238 797473	39,95
0150295	55-622	29 x 2.20	● foldable	785	45-58	4 019238 797497	39,95
0150297	58-622	29 x 2.30	● foldable	825	40-54	4 019238 798326	39,95
0150502	65-622	29 x 2.60	● foldable	995	29-44	4 019238 037258	44,95



CONTI KNOWLEDGE

Tubeless Ready:

For initial mounting we recommend to use at least 30 ml of Conti RevoSealant per tire. Then spin the tire (wheel) to spread the Conti RevoSealant inside of the tire and pump to the allowed maximum pressure. Check the pressure before the next ride and adjust to your desired PSI.



Cross King



TECHNOLOGY



SIZES PROTECTION



SIZES SHIELDWALL



SIZES WIRE

Cross King

Wire - 3/180 TPI

E25

Article	ETRTO	Dimension	Color/sidewall	g	PSI	EAN	RRP/€
0101687	50-406	20 x 2.00	● Wire	460	51-65	4 019238 026344	14,95
0101688	50-507	24 x 2.00	● Wire	565	51-65	4 019238 026337	19,95
0150399	50-559	26 x 2.00	● Wire	600	51-65	4 019238 024968	24,95
0150404	55-559	26 x 2.20	● Wire	670	44-58	4 019238 024999	24,95
0150407	58-559	26 x 2.30	● Wire	710	40-54	4 019238 025019	24,95
0150402	50-584	27.5 x 2.00	● Wire	675	51-65	4 019238 024975	24,95
0150405	55-584	27.5 x 2.20	● Wire	740	44-58	4 019238 025002	24,95
0150408	58-584	27.5 x 2.30	● Wire	775	40-54	4 019238 025033	24,95
0150403	50-622	29 x 2.00	● Wire	720	51-65	4 019238 024982	24,95
0150406	55-622	29 x 2.20	● Wire	785	44-58	4 019238 025026	24,95
0150410	58-622	29 x 2.30	● Wire	820	40-54	4 019238 025057	24,95



Race King



TECHNOLOGY



SIZES PROTECTION



SIZES SHIELDWALL



SIZES WIRE



„BERNSTEIN”

FIRST CHOICE FOR RACERS

Classic competition tire which feels at home at the Cross Country World Cup or at marathons. Low rolling resistance, good self-damping and low weight make it the right choice for all race bikes.



TECHNOLOGY



SIZES PROTECTION



SIZES SHIELDWALL



SIZES WIRE



With our unique tread compound, we have revolutionized the sport of cycling. With the legendary **BlackChili Compound** we have answered the eternal question of the best balance of grip and rolling resistance for cycling. The latest polymers as well as specially developed carbon black particles and filler materials guarantee unique performance, be it on a road, gravel or a mountain bike, for time trialling or downhill.



The extra all-round puncture protection layer renders the casings extremely durable and resistant to damage or penetration from foreign elements. Treads and sidewalls are equally protected, and are 25% lighter and offer 30% more puncture protection than their predecessors protected by DuraSkin®. Rolling resistance and absorption has also significantly improved. The new Revolution Tubeless Ready Bead improves the installation of Tubeless Ready Tires. For tubeless sealing we recommend the use of Continental RevoSealant.



PureGrip Compound is derived from an activated Silica compound and is a good example of how we integrate customer feedback continuously into our research and development. This mixture technology fits in perfectly alongside the BlackChili Compound. The name PureGrip does exactly what it says; exceptionally good grip and durability are the distinguishing features of this compound. Engineered with PureGrip in our Performance products in our road and mountain bike ranges.



The **ShieldWall System** combines the optimum combination of high puncture protection and the low rolling resistance with low weight. This is made possible by an additional, all-round puncture protection layer, which consists of a finely woven cross fabric. This gives the tire a high resistance to punctures and damage. Despite its additional ply, the tire has a very good damping property and a high degree of flexibility to adapt perfectly to the ground. The revolutionary tubeless ready bead allows easy and uncomplicated mounting of the tire. For best results in sealing and in use, we recommend the use of the new Continental RevoSealant sealant.



Race King



TECHNOLOGY



SIZES PROTECTION



SIZES SHIELDWALL



SIZES WIRE

Race King

BlackChili Compound - ProTecton - 3/180 TPI

E25 TR

Article	ETRTO	Dimension	Color/sidewall	g	PSI	EAN	RRP/€
0101961	55-559	26 x 2.20	foldable	555	44-58	4 019238 071511	64,95
0101486	55-559	26 x 2.20	foldable	540	44-58	4 019238 798111	64,95
0101962	55-584	27.5 x 2.20	foldable	580	44-58	4 019238 071504	64,95
0101467	55-584	27.5 x 2.20	foldable	570	44-58	4 019238 798135	64,95
0101963	55-622	29 x 2.20	foldable	615	44-58	4 019238 071498	64,95
0101473	55-622	29 x 2.20	foldable	605	44-58	4 019238 798128	64,95



CONTI KNOWLEDGE

Tubeless Ready:

For initial mounting we recommend to use at least 30 ml of Conti RevoSealant per tire. Then spin the tire (wheel) to spread the Conti RevoSealant inside of the tire and pump to the allowed maximum pressure. Check the pressure before the next ride and adjust to your desired PSI.



Race King



TECHNOLOGY



SIZES PROTECTION



SIZES SHIELDWALL



SIZES WIRE

Race King

PureGrip Compound - ShieldWall System - 3/180 TPI

E25 TR

Article	ETRTO	Dimension	Color/sidewall	g	PSI	EAN	RRP/€
0150311	50-559	26 x 2.00	● foldable	545	51-65	4 019238 797510	39,95
0150304	55-559	26 x 2.20	● foldable	640	44-58	4 019238 797541	39,95
0150309	50-584	27.5 x 2.00	● foldable	625	51-65	4 019238 797527	39,95
0150292	55-584	27.5 x 2.20	● foldable	695	44-58	4 019238 797565	39,95
0150307	50-622	29 x 2.00	● foldable	660	51-65	4 019238 797534	39,95
0150296	55-622	29 x 2.20	● foldable	740	44-58	4 019238 797558	39,95



CONTI KNOWLEDGE

Tubeless Ready:

For initial mounting we recommend to use at least 30 ml of Conti RevoSealant per tire. Then spin the tire (wheel) to spread the Conti RevoSealant inside of the tire and pump to the allowed maximum pressure. Check the pressure before the next ride and adjust to your desired PSI.



Race King



TECHNOLOGY



SIZES PROTECTION



SIZES SHIELDWALL



SIZES WIRE

Race King

Wire - 3/180 TPI

E25

Article	ETRTO	Dimension	Color/sidewall	g	PSI	EAN	RRP/€
0150429	50-559	26 x 2.00	● Wire	555	51-65	4 019238 026153	24,95
0150432	55-559	26 x 2.20	● Wire	650	44-58	4 019238 026122	24,95
0150445	50-584	27.5 x 2.00	● Wire Refl.	650	51-65	4 019238 026221	29,95
0150430	50-584	27.5 x 2.00	● Wire	640	51-65	4 019238 026146	24,95
0150525	55-584	27.5 x 2.20	● Wire Refl.	710	44-58	4 019238 048377	29,95
0150433	55-584	27.5 x 2.20	● Wire	710	44-58	4 019238 026115	24,95
0150446	50-622	29 x 2.00	● Wire Refl.	680	51-65	4 019238 026214	29,95
0150431	50-622	29 x 2.00	● Wire	680	51-65	4 019238 026139	24,95
0150527	55-622	29 x 2.20	● Wire Refl.	730	44-58	4 019238 048391	29,95
0150435	55-622	29 x 2.20	● Wire	730	44-58	4 019238 026092	24,95



Ruban

eRuban Plus



TECHNOLOGY



SIZES RUBAN SHIELDWALL



SIZES RUBAN WIRE



SIZES eRUBAN





TECHNOLOGY



SIZES RUBAN SHIELDWALL



SIZES RUBAN WIRE



SIZES eRUBAN



FROM RURAL TO URBAN

The energy-saving SUV allrounder that gets you to both Rural and Urban. The partner for your commute, running errands and the weekend tour.



PureGrip Compound is derived from an activated Silica compound and is a good example of how we integrate customer feedback continuously into our research and development. This mixture technology fits in perfectly alongside the BlackChili Compound. The name PureGrip does exactly what it says; exceptionally good grip and durability are the distinguishing features of this compound. Engineered with PureGrip in our Performance products in our road and mountain bike ranges.



With **PolyX Breaker™** car expertise comes to the bicycle tire sector. Polyester has been used successfully for years in car tires and has proved extremely effective. The extremely resistant polyester fibre is woven tightly crosswise. A very high fabric density is achieved which makes the breaker resistant not only to foreign bodies, but especially to punctures. The rolling resistance is not affected by this breaker.



The **ShieldWall System** combines the optimum combination of high puncture protection and the low rolling resistance with low weight. This is made possible by an additional, all-round puncture protection layer, which consists of a finely woven cross fabric. This gives the tire a high resistance to punctures and damage. Despite its additional ply, the tire has a very good damping property and a high degree of flexibility to adapt perfectly to the ground. The revolutionary tubeless ready bead allows easy and uncomplicated mounting of the tire. For best results in sealing and in use, we recommend the use of the new Continental RevoSealant sealant.



TECHNOLOGY



SIZES RUBAN SHIELDWALL



SIZES RUBAN WIRE



SIZES eRUBAN

Ruban

PureGrip Compound - ShieldWall System - 3/180 TPI

E25 TR

Article	ETRTO	Dimension	Color/sidewall	g	PSI	EAN	RRP/€
0150574	54-584	27.5 x 2.10	● foldable	650	44-58	4 019238 056358	39,95
0150575	58-584	27.5 x 2.30	● foldable	795	40-55	4 019238 056280	39,95
0150576	65-584	27.5 x 2.60	● foldable	870	29-44	4 019238 056297	44,95
0150577	54-622	29 x 2.10	● foldable	695	44-58	4 019238 056303	39,95
0150578	58-622	29 x 2.30	● foldable	845	40-55	4 019238 056310	39,95
0150579	65-622	29 x 2.60	● foldable	925	29-44	4 019238 056327	44,95



CONTI KNOWLEDGE

Tubeless Ready:

For initial mounting we recommend to use at least 30 ml of Conti RevoSealant per tire. Then spin the tire (wheel) to spread the Conti RevoSealant inside of the tire and pump to the allowed maximum pressure. Check the pressure before the next ride and adjust to your desired PSI.

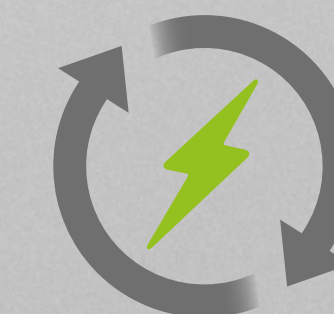

Specifically designed for the use on electrified bikes





TECHNOLOGY



SIZES RUBAN SHIELDWALL



SIZES RUBAN WIRE



SIZES eRUBAN

Ruban

Wire - 3/180 TPI

E25

Article	ETRTO	Dimension	Color/sidewall	g	PSI	EAN	RRP/€
0150534	54-584	27.5 x 2.10	● Wire	655	44-58	4 019238 048568	27,95
0150535	54-584	27.5 x 2.10	● Wire refl.	660	44-58	4 019238 048551	32,95
0150536	58-584	27.5 x 2.30	● Wire	795	40-55	4 019238 048582	27,95
0150537	58-584	27.5 x 2.30	● Wire refl.	800	40-55	4 019238 048575	32,95
0150538	65-584	27.5 x 2.60	● Wire	865	29-44	4 019238 048605	32,95
0150539	65-584	27.5 x 2.60	● Wire refl.	875	29-44	4 019238 048599	37,95
0150540	54-622	29 x 2.10	● Wire	700	44-58	4 019238 048629	27,95
0150541	54-622	29 x 2.10	● Wire refl.	705	44-58	4 019238 048612	32,95
0150545	58-622	29 x 2.30	● Wire	840	40-55	4 019238 048643	27,95
0150546	58-622	29 x 2.30	● Wire refl.	850	40-55	4 019238 048636	32,95
0150547	65-622	29 x 2.60	● Wire	925	29-44	4 019238 048667	32,95
0150548	65-622	29 x 2.60	● Wire refl.	920	29-44	4 019238 048650	37,95

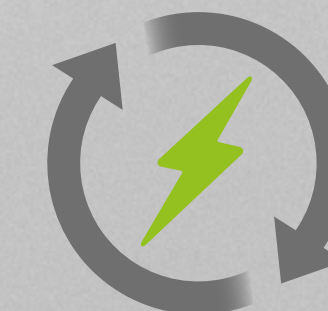

Specifically designed for the use on electrified bikes





TECHNOLOGY



SIZES RUBAN SHIELDWALL



SIZES RUBAN WIRE



SIZES eRUBAN

eRuban Plus

PureGrip Compound - PolyX Breaker™ - Wire - 3/180 TPI

E50

Article	ETRTO	Dimension	Color/sidewall	g	PSI	EAN	RRP/€
0150550	58-559	26 x 2.30	● Wire	800	40-55	4 019238 048919	36,95
0150555	58-559	26 x 2.30	● Wire refl.	810	40-55	4 019238 048865	41,95
0150549	58-584	27.5 x 2.30	● Wire	840	40-55	4 019238 048926	36,95
0150556	58-584	27.5 x 2.30	● Wire refl.	845	40-55	4 019238 048858	41,95
0150551	65-584	27.5 x 2.60	● Wire	920	29-44	4 019238 048902	41,95
0150557	65-584	27.5 x 2.60	● Wire refl.	925	29-44	4 019238 048841	46,95
0150552	54-622	29 x 2.10	● Wire	735	44-58	4 019238 048896	36,95
0150558	54-622	29 x 2.10	● Wire refl.	740	44-58	4 019238 048834	41,95
0150553	58-622	29 x 2.30	● Wire	880	40-55	4 019238 048889	36,95
0150559	58-622	29 x 2.30	● Wire refl.	885	40-55	4 019238 048827	41,95
0150560	65-622	29 x 2.60	● Wire	975	29-44	4 019238 048872	41,95
0150554	65-622	29 x 2.60	● Wire refl.	980	29-44	4 019238 048810	46,95

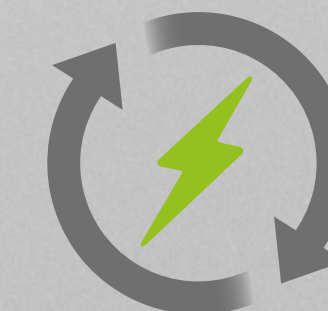

Specifically designed for the use on electrified bikes



Double Fighter III



TECHNOLOGY



SIZES



Double Fighter III

AN URBAN ADVENTURER WITH REAL VERSATILITY

Light rolling and quiet on tarmac, yet grips on tracks and gravel roads.



TECHNOLOGY



SIZES

Double Fighter III

Wire - 3/180 TPI

Article	ETRTO	Dimension	Color/sidewall	g	PSI	EAN	RRP/€
0101232	47-305	16 x 1.75	● Wire	380	51-65	4 019238 709810	14,95
0101282	47-305	16 x 1.75	● Wire refl.	380	51-65	4 019238 732429	17,95
0101233	47-406	20 x 1.75	● Wire	520	51-65	4 019238 709827	14,95
0101283	47-406	20 x 1.75	● Wire refl.	520	51-65	4 019238 732412	17,95
0101234	47-507	24 x 1.75	● Wire	620	51-65	4 019238 709834	17,95
0101284	47-507	24 x 1.75	● Wire refl.	620	51-65	4 019238 732405	20,95
0101251	50-507	24 x 2.0	● Wire	650	51-65	4 019238 721126	17,95
0101285	50-507	24 x 2.0	● Wire refl.	650	51-65	4 019238 732399	20,95
0101235	50-559	26 x 1.90	● Wire	790	51-65	4 019238 709858	21,95
0101286	50-559	26 x 1.90	● Wire refl.	790	51-65	4 019238 732382	24,95
0101237	50-584	27.5 x 2.00	● Wire	860	51-65	4 019238 709872	21,95
0101287	50-584	27.5 x 2.00	● Wire refl.	860	51-65	4 019238 732375	24,95
0100795	37-622	700 x 35C	● Wire	550	58-85	4 019238 601671	21,95
0101289	37-622	700 x 35C	● Wire refl.	550	58-85	4 019238 732436	24,95
0101239	50-622	29 x 2.00	● Wire	915	50-65	4 019238 709896	21,95
0101292	50-622	29 x 2.00	● Wire refl.	915	50-65	4 019238 732368	24,95



Terra Speed



Terra Trail



Terra Hardpack

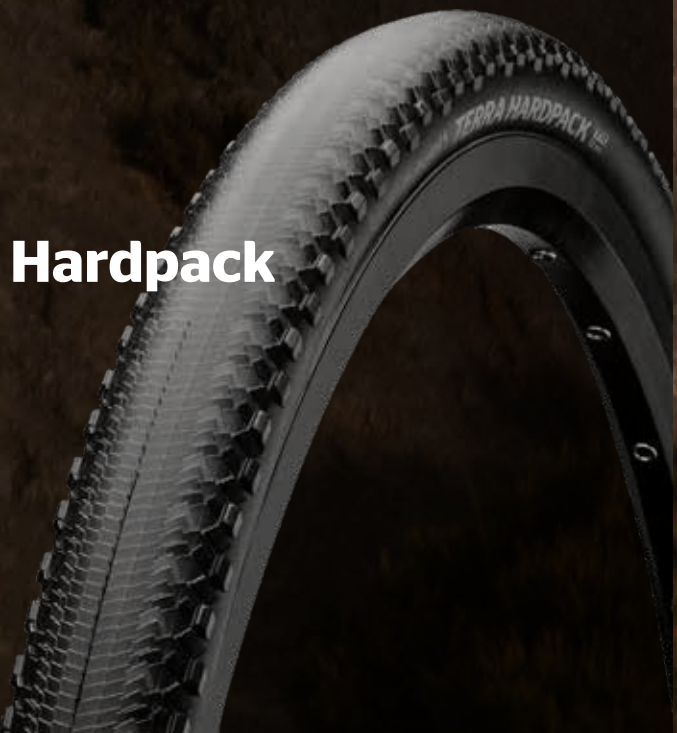

GRAVEL



Terra Speed



TECHNOLOGY



SIZES



CHOOSE ALTER ROAD, CHOOSE TERRA

For your way off-road. For more comfort. For the adventure. Be it the long tour, or the shortcut on your way home. Made to get you over rough and smooth.



TECHNOLOGY



With our unique tread compound, we have revolutionized the sport of cycling. With the legendary **BlackChili Compound** we have answered the eternal question of the best balance of grip and rolling resistance for cycling. The latest polymers as well as specially developed carbon black particles and filler materials guarantee unique performance, be it on a road, gravel or a mountain bike, for time trialling or downhill.



The extra all-round puncture protection layer renders the casings extremely durable and resistant to damage or penetration from foreign elements. Treads and sidewalls are equally protected, and are 25% lighter and offer 30% more puncture protection than their predecessors protected by DuraSkin®. Rolling resistance and absorption has also significantly improved. The new Revolution Tubeless Ready Bead improves the installation of Tubeless Ready Tires. For tubeless sealing we recommend the use of Continental RevoSealant.



SIZES



Terra Speed

Terra Speed

BlackChili Compound - ProTecton - 3/180 TPI

E25 TR

Article	ETRTO	Dimension	Color/sidewall	g	PSI	EAN	RRP/€
0101719	35-584	650 X 35B	● foldable	400	44-73	4 019238 029796	64,95
0101720	35-584	650 X 35B	● foldable	400	44-73	4 019238 029772	64,95
0101717	40-584	650 X 40B	● foldable	440	44-73	4 019238 029635	64,95
0101718	40-584	650 X 40B	● foldable	440	44-73	4 019238 029611	64,95
0101693	35-622	700 X 35C	● foldable	420	44-73	4 019238 027013	64,95
0101700	35-622	700 X 35C	● foldable	415	44-73	4 019238 026955	64,95
0101694	40-622	700 X 40C	● foldable	455	44-73	4 019238 027099	64,95
0101702	40-622	700 X 40C	● foldable	455	44-73	4 019238 027020	64,95
0101837	40-622	700 X 40C	● foldable	470	44-73	4 019238 052053	64,95
0102016	45-622	700 X 45C	● foldable	560	44-65	4 019238 093094	64,95
0102007	45-622	700 X 45C	● foldable	535	44-65	4 019238 083439	64,95



CONTI KNOWLEDGE

Tubeless Ready:

For initial mounting we recommend to use at least 30 ml of Conti RevoSealant per tire. Then spin the tire (wheel) to spread the Conti RevoSealant inside of the tire and pump to the allowed maximum pressure. Check the pressure before the next ride and adjust to your desired PSI.



This tire is Hookless compatible to its limited max. pressure. Please check wheel instruction and tire packaging for detailed information.



TECHNOLOGY



SIZES

STREET											
OFFROAD / BIKEPACKING											



Terra Trail



TECHNOLOGY



SIZES PROTECTION



SIZES SHIELDWALL



CHOOSE ALTER ROAD, CHOOSE TERRA

For your way off-road. For more comfort. For the adventure. Be it the long tour, or the shortcut on your way home. Made to get you over rough and smooth.



TECHNOLOGY



SIZES PROTECTION



SIZES SHIELDWALL



With our unique tread compound, we have revolutionized the sport of cycling. With the legendary **BlackChili Compound** we have answered the eternal question of the best balance of grip and rolling resistance for cycling. The latest polymers as well as specially developed carbon black particles and filler materials guarantee unique performance, be it on a road, gravel or a mountain bike, for time trialling or downhill.



The extra all-round puncture protection layer renders the casings extremely durable and resistant to damage or penetration from foreign elements. Treads and sidewalls are equally protected, and are 25% lighter and offer 30% more puncture protection than their predecessors protected by DuraSkin®. Rolling resistance and absorption has also significantly improved. The new Revolution Tubeless Ready Bead improves the installation of Tubeless Ready Tires. For tubeless sealing we recommend the use of Continental RevoSealant.



PureGrip Compound is derived from an activated Silica compound and is a good example of how we integrate customer feedback continuously into our research and development. This mixture technology fits in perfectly alongside the BlackChili Compound. The name PureGrip does exactly what it says; exceptionally good grip and durability are the distinguishing features of this compound. Engineered with PureGrip in our Performance products in our road and mountain bike ranges.



The **ShieldWall System** combines the optimum combination of high puncture protection and the low rolling resistance with low weight. This is made possible by an additional, all-round puncture protection layer, which consists of a finely woven cross fabric. This gives the tire a high resistance to punctures and damage. Despite its additional ply, the tire has a very good damping property and a high degree of flexibility to adapt perfectly to the ground. The revolutionary tubeless ready bead allows easy and uncomplicated mounting of the tire. For best results in sealing and in use, we recommend the use of the new Continental RevoSealant sealant.



Terra Trail



TECHNOLOGY



SIZES PROTECTION



SIZES SHIELDWALL

Terra Trail

BlackChili Compound - ProTecton - 3/180 TPI

E25 TR

Article	ETRTO	Dimension	Color/sidewall	g	PSI	EAN	RRP/€
0101715	40-584	650 X 40B	● foldable	420	44-73	4 019238 029673	64,95
0101716	40-584	650 X 40B	● foldable	415	44-73	4 019238 029659	64,95
0101944	40-584	650 X 40B	● foldable	430	44-73	4 019238 064544	64,95
0101697	40-622	700 X 40C	● foldable	440	44-73	4 019238 027075	64,95
0101701	40-622	700 X 40C	● foldable	435	44-73	4 019238 027044	64,95
0101836	40-622	700 X 40C	● foldable	450	44-73	4 019238 052060	64,95



CONTI KNOWLEDGE

Tubeless Ready:

For initial mounting we recommend to use at least 30 ml of Conti RevoSealant per tire. Then spin the tire (wheel) to spread the Conti RevoSealant inside of the tire and pump to the allowed maximum pressure. Check the pressure before the next ride and adjust to your desired PSI.



This tire is Hookless compatible to its limited max. pressure. Please check wheel instruction and tire packaging for detailed information.

STREET

OFFROAD / BIKEPACKING





TECHNOLOGY



SIZES PROTECTION



SIZES SHIELDWALL

Terra Trail

PureGrip Compound - ShieldWall System - 3/180 TPI

E25 TR

Article	ETRTO	Dimension	Color/sidewall	g	PSI	EAN	RRP/€
0150509	47-584	650 X 47B	● foldable	480	36-65	4 019238 038507	39,95
0150508	47-584	650 X 47B	● foldable	485	36-65	4 019238 038538	39,95
0150503	35-622	700 X 35C	● foldable	385	44-73	4 019238 038460	39,95
0150505	35-622	700 X 35C	● foldable	410	44-73	4 019238 038491	39,95
0150507	40-622	700 X 40C	● foldable	450	44-73	4 019238 038545	39,95
0150673	40-622	700 X 40C	● foldable	440	44-73	4 019238 064506	39,95
0150675	45-622	700 X 45C	● foldable	495	36-65	4 019238 064476	39,95
0150674	45-622	700 X 45C	● foldable	495	36-65	4 019238 064483	39,95



CONTI KNOWLEDGE

Tubeless Ready:

For initial mounting we recommend to use at least 30 ml of Conti RevoSealant per tire. Then spin the tire (wheel) to spread the Conti RevoSealant inside of the tire and pump to the allowed maximum pressure. Check the pressure before the next ride and adjust to your desired PSI.



This tire is Hookless compatible to its limited max. pressure. Please check wheel instruction and tire packaging for detailed information.

STREET

OFFROAD / BIKEPACKING



Terra Hardpack



TECHNOLOGY



SIZES



CHOOSE ALTER ROAD, CHOOSE TERRA

For your way off-road. For more comfort. For the adventure. Be it the long tour, or the shortcut on your way home. Made to get you over rough and smooth.



TECHNOLOGY



PureGrip Compound is derived from an activated Silica compound and is a good example of how we integrate customer feedback continuously into our research and development. This mixture technology fits in perfectly alongside the BlackChili Compound. The name PureGrip does exactly what it says; exceptionally good grip and durability are the distinguishing features of this compound. Engineered with PureGrip in our Performance products in our road and mountain bike ranges.



The **ShieldWall System** combines the optimum combination of high puncture protection and the low rolling resistance with low weight. This is made possible by an additional, all-round puncture protection layer, which consists of a finely woven cross fabric. This gives the tire a high resistance to punctures and damage. Despite its additional ply, the tire has a very good damping property and a high degree of flexibility to adapt perfectly to the ground. The revolutionary tubeless ready bead allows easy and uncomplicated mounting of the tire. For best results in sealing and in use, we recommend the use of the new Continental RevoSealant sealant.



SIZES



Terra Hardpack

Terra Hardpack

PureGrip Compound - ShieldWall System - 3/180 TPI

E25 **TR**

Article	ETRTO	Dimension	Color/sidewall	g	PSI	EAN	RRP/€
0150563	50-584	650 X 50B	● foldable	530	50-65	4 019238 052114	39,95
0150565	50-622	700 X 50C	● foldable	565	50-65	4 019238 052107	39,95



CONTI KNOWLEDGE

Tubeless Ready:

For initial mounting we recommend to use at least 30 ml of Conti RevoSealant per tire. Then spin the tire (wheel) to spread the Conti RevoSealant inside of the tire and pump to the allowed maximum pressure. Check the pressure before the next ride and adjust to your desired PSI.



This tire is Hookless compatible to its limited max. pressure. Please check wheel instruction and tire packaging for detailed information.



TECHNOLOGY



SIZES

STREET

OFFROAD / BIKEPACKING



Pure CONTACT

eCONTACT Plus

CONTACT Plus

CONTACT Plus City

CONTACT

CONTACT Urban

CONTACT Speed

CONTACT Spike

Top CONTACT II

Top CONTACT Winter II

Urban Taraxagum

Super Sport Plus

RIDE Tour

RIDE City



URBAN



TECHNOLOGY



SIZES



FEATURES



SUSTAINABILITY



PURE CONTACT. BUILT TOUGH TO RIDE SMOOTH.

Created for urban riders who want confidence to commute, shop, and explore. A cutting-edge combination of Vectran and PolyX breaker technologies take protection to a whole new level, alongside more sustainable manufacturing using responsibly sourced rubber and more natural materials.



TECHNOLOGY



SIZES



FEATURES



SUSTAINABILITY

Vectran™ BREAKER

Vectran is spun from liquid crystal-polymer. This way a thermoplastic, multiple-thread yarn is created. As a comparison: This partially crystalline fabric is more cut-resistant than aramide and its tensile strength is five times higher than that of steel. A Vectran breaker is lighter, more flexible and effective against cuts than a comparable nylon breaker. Without effecting rolling resistance.

PolyX Breaker™

With **PolyX Breaker™** car expertise comes to the bicycle tire sector. Polyester has been used successfully for years in car tires and has proved extremely effective. The extremely resistant polyester fibre is woven tightly crosswise. A very high fabric density is achieved which makes the breaker resistant not only to foreign bodies, but especially to punctures. The rolling resistance is not affected by this breaker.

E50

Suitable for E-Bikes: For our E-Bike tire we fall back on over 100 years' experience with moped and motorcycle tires. All of our city/trekking tires are rated to a standard speed of at least 25 km/h. Those tires marked E50 are also certified for S-Pedelecs. With their high quality structure, puncture protection is high and the rolling resistance is low offering protection from premature wear brought about by the additional driving force.



Pure CONTACT



TECHNOLOGY



SIZES



FEATURES



SUSTAINABILITY

Pure CONTACT

Vectran Breaker - PolyX Breaker - 3/180 TPI

GRX

E50

8

Article	ETRTO	Dimension	Color/sidewall	g	PSI	kg+	EAN	RRP/€
0101949	47-622	28 x 1.75	● foldable refl.	670	55-73	115	4019238065022	59,95
0101967	50-584	27.5 x 2.00	● foldable refl.	715	36-65	125	4019238072419	59,95
0101968	55-584	27.5 x 2.20	● foldable refl.	800	36-58	125	4019238072426	59,95
0101969	60-584	27.5 x 2.40	● foldable refl.	885	44-51	121	4019238072433	59,95
0101970	40-622	28 x 1.50	● foldable refl.	590	44-73	115	4019238072402	59,95
0101971	50-622	28 x 2.00	● foldable refl.	750	36-65	128	4019238072488	59,95
0101972	55-622	28 x 2.20	● foldable refl.	790	36-58	132	4019238072495	59,95
0101982	50-584	27.5 x 2.00	● foldable refl.	655	36-65	125	4019238074017	61,95
0101983	55-584	27.5 x 2.20	● foldable refl.	760	36-58	125	4019238074000	61,95
0101984	60-584	27.5 x 2.40	● foldable refl.	835	44-51	121	4019238073997	61,95
0101985	40-622	28 x 1.50	● foldable refl.	575	44-73	115	4019238073980	61,95
0101986	47-622	28 x 1.75	● foldable refl.	610	55-73	115	4019238073973	61,95
0101987	50-622	28 x 2.00	● foldable refl.	695	36-65	128	4019238073966	61,95
0101988	55-622	28 x 2.20	● foldable refl.	755	36-58	132	4019238073959	61,95

Vectran™
BREAKER

PolyX Breaker™

E50

SAFETY LEVEL



1

2

3

4

5

6

7

8

8

Puncture Protection Level 8:

Vectran Breaker, our high-quality racing tire technology, meets PolyX Breaker technology, which has proven to be extremely effective in car tires for years. The combination provides the **best puncture protection** in our Range.

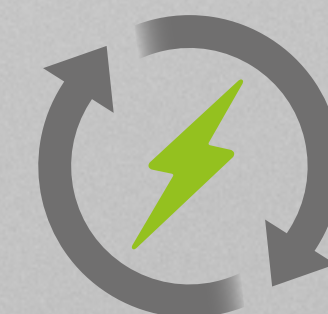

Specifically designed for the use on electrified bikes

E50



Pure CONTACT



TECHNOLOGY



SIZES



FEATURES



SUSTAINABILITY

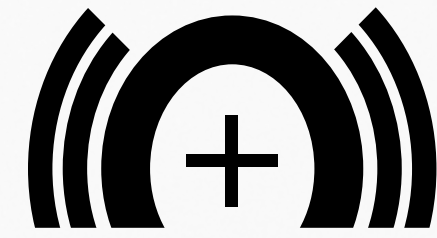

Safety Level 8

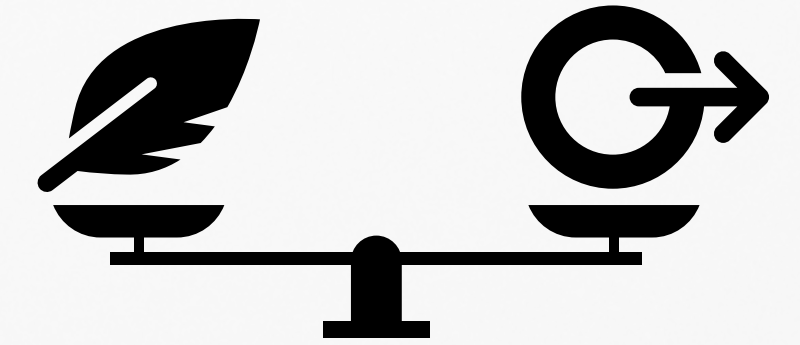

Battery saving lightweight + rolling resistance

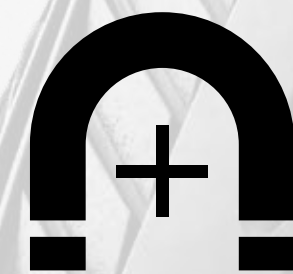

Outstanding grip (wet and dry)



Our most sustainable tire



Pure CONTACT



TECHNOLOGY



SIZES



FEATURES



SUSTAINABILITY

Our path to sustainability:

created from one-third sustainable materials – silicate from the ash of rice husks, responsibly sourced natural rubber and renewable softener, engineered into one of our high performing tires.



Silicate from the Ash of Rice Husks

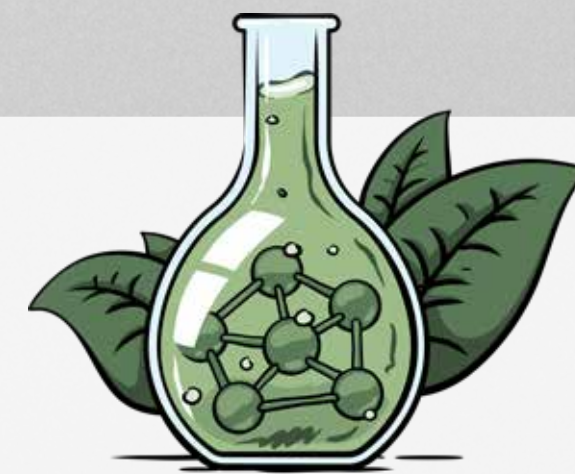

Additives with recycled feedstock



Rapeseed Oil



Responsible sourced Natural Rubber



eCONTACT Plus



TECHNOLOGY



SIZES



FEATURES





TECHNOLOGY



SIZES



FEATURES



THE ULTIMATE IN CONFIDENCE AND COMFORT

Specifically developed for the commuting and load-carrying demands of e-bikes. This high-mileage tire features a compact tread pattern to keep rolling resistance low, boosting the range of each battery charge.

Safety + Pro

Engineered for the unique demands of modern e-bikes and cargo bikes up to 50km/h. Our **SafetyPlus Pro Breaker** technology combines highly flexible rubber with the proven strength of our tightly woven PolyX puncture-resistant fibers. The high elasticity keeps rolling resistance low, prolonging the e-bike battery life so you get more miles from each charge. When riding with heavy loads, the SafetyPlus Pro Breaker contributes to confident handling through busy traffic and sharp corners, no matter the conditions.



Suitable for E-Bikes: For our E-Bike tire we fall back on over 100 years' experience with moped and motorcycle tires. All of our city/trekking tires are rated to a standard speed of at least 25 km/h. Those tires marked E50 are also certified for S-Pedelecs. With their high quality structure, puncture protection is high and the rolling resistance is low offering protection from premature wear brought about by the additional driving force.



TECHNOLOGY



SIZES



FEATURES

eCONTACT Plus

SafetyPlus Pro Breaker - 3/180 TPI -

E50 **7**

Article	ETRTO	Dimension	Color/sidewall	g	PSI	kg+	EAN	RRP/€
0101973	50-406	20 x 2.00	● Wire refl.	745	50-73	85	4 019238 073171	49,95
0101974	55-406	20 x 2.20	● Wire refl.	770	45-73	90	4 019238 073164	49,95
0101975	62-406	20 x 2.50	● Wire refl.	835	45-58	115	4 019238 073157	49,95
0101976	55-559	26 x 2.20	● Wire refl.	1100	36-65	128	4 019238 073140	49,95
0101977	55-584	27.5 x 2.20	● Wire refl.	1195	36-65	128	4 019238 073133	49,95
0101978	62-584	27.5 x 2.50	● Wire refl.	1220	36-65	128	4 019238 073126	49,95
0101979	50-622	28 x 2.00	● Wire refl.	1095	45-73	121	4 019238 073119	49,95
0101980	55-622	28 x 2.20	● Wire refl.	1150	36-65	128	4 019238 073102	49,95
0101981	62-622	28 x 2.50	● Wire refl.	1270	36-58	128	4 019238 073096	49,95

Safety + Pro

SAFETY LEVEL



1

2

3

4

5

6

7

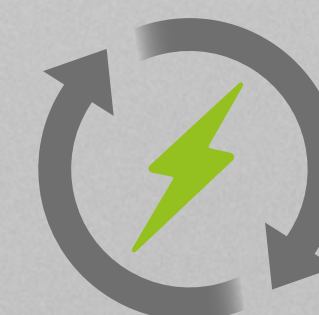

Specifically designed for the use on electrified bikes



eCONTACT Plus



TECHNOLOGY



SIZES



FEATURES



Loads up to 128 kg

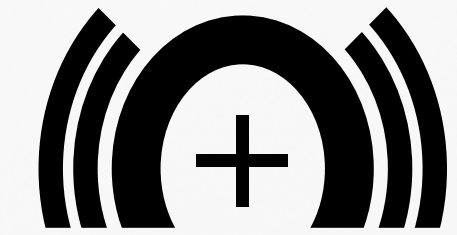

Superior Puncture Protection



High mileage

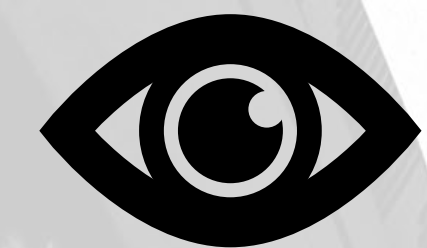

High visibility

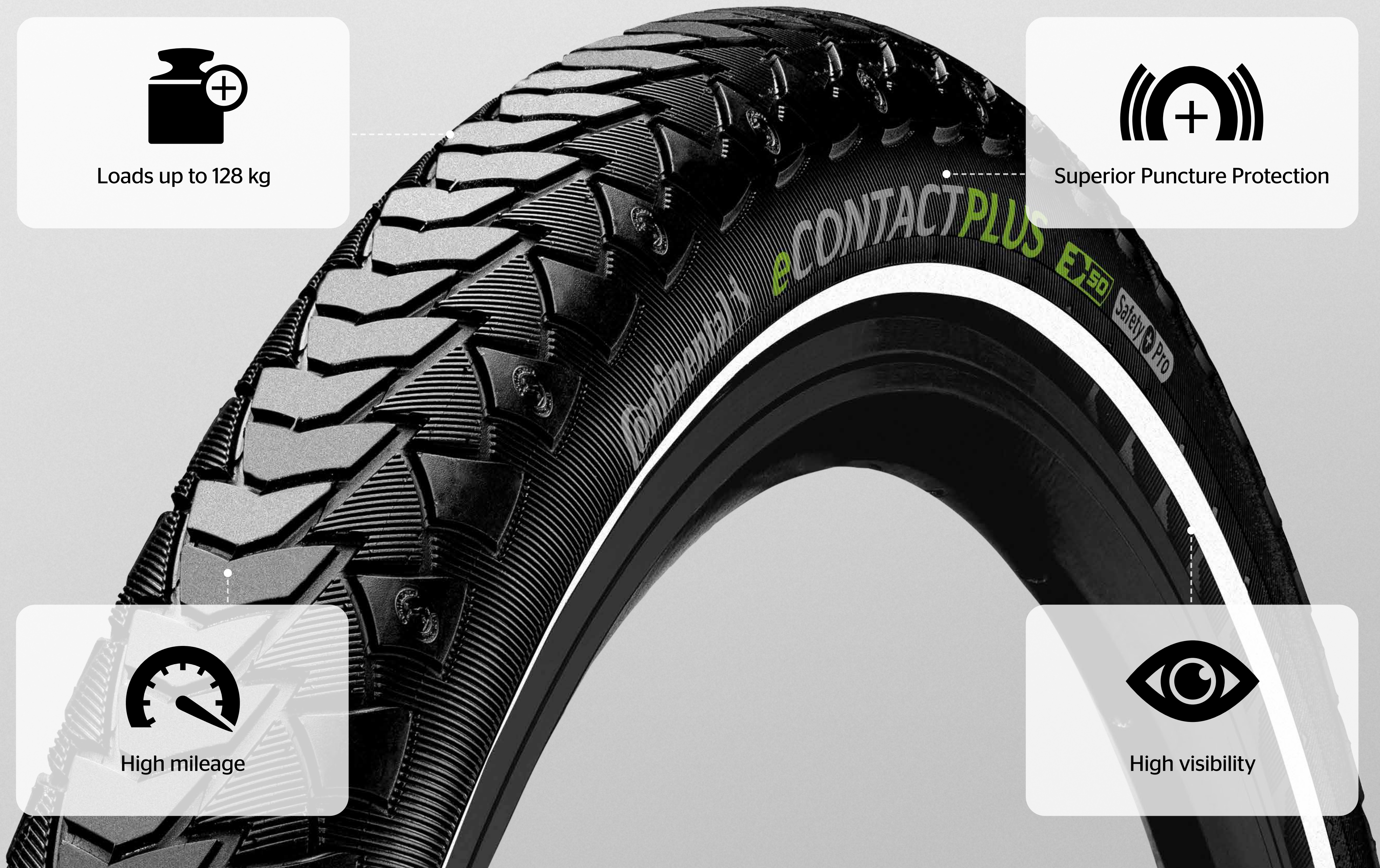

CONTACT Plus



TECHNOLOGY



SIZES



ALL YOU WOULD EXPECT

An allrounder on any type of roads and paths that enhances every bike. Thanks to the plus in puncture protection, nobody will be left behind with a flat tire. ECE-R75-certified, designated for usage on e-bikes up to 50 km/h.



TECHNOLOGY

Safety

Specially designed for e-bikes up to 50 km/h, we have combined our **SafetySystem Breaker** with a highly flexible natural rubber. The result is an extremely cut and puncture resistant breaker ply which has a low rolling resistance thanks to its high elasticity. This helps saving battery life and the environment. High acceleration torques and fast speeds in turns are easily absorbed by the breaker. The specialist for fast e-bikes and rental bikes.



Suitable for E-Bikes: For our E-Bike tire we fall back on over 100 years' experience with moped and motorcycle tires. All of our city/trekking tires are rated to a standard speed of at least 25 km/h. Those tires marked E50 are also certified for S-Pedelecs. With their high quality structure, puncture protection is high and the rolling resistance is low offering protection from premature wear brought about by the additional driving force.



SIZES



CONTACT Plus

CONTACT Plus

SafetyPlus Breaker - 3/180 TPI - **E50**  **7**

Article	ETRTO	Dimension	Color/sidewall	g	PSI	kg+	EAN	RRP/€
0101001	47-507	24 x 1.75	● Wire refl.	940	45-58	90	4 019238 639971	44,95
0101002	47-559	26 x 1.75	● Wire refl.	1040	45-58	109	4 019238 639964	44,95
0101221	42-584	27.5 x 1½	● Wire refl.	990	50-65	100	4 019238 698138	44,95
0101003	28-622	28 x 1⅝ x 1⅝	● Wire refl.	645	80-102	85	4 019238 639957	44,95
0101004	32-622	28 x 1⅜ x 1⅝	● Wire refl.	750	70-85	90	4 019238 639940	44,95
0101005	37-622	28 x 1¼ x 1¾	● Wire refl.	980	56-85	100	4 019238 639933	44,95
0101816	40-622	28 x 1.50	● Wire refl.	1025	58-94	100	4 019238 043396	44,95
0101006	42-622	28 x 1.60	● Wire refl.	1050	50-73	100	4 019238 639926	44,95
0101007	47-622	28 x 1.75	● Wire refl.	1150	45-58	95	4 019238 639988	44,95
0101008	42-635	28 x 1½	● Wire refl.	1070	50-65	100	4 019238 639995	44,95

Safety **E50**

SAFETY LEVEL



1

2

3

4

5

6

7



TECHNOLOGY



SIZES



CONTACT Plus City



TECHNOLOGY



SIZES





TECHNOLOGY



SIZES

OUT AND ABOUT IN TOWN

Exactly the right tire to explore the city securely and relaxed thanks to a tread pattern made for tarmac, efficient rolling characteristics, and a maximum of puncture protection. With its ECE-R75-certification, cyclists can ride economically and save energy even on e-bikes up to 50 km/h.

Safety

Specially designed for e-bikes up to 50 km/h, we have combined our **SafetySystem Breaker** with a highly flexible natural rubber. The result is an extremely cut and puncture resistant breaker ply which has a low rolling resistance thanks to its high elasticity. This helps saving battery life and the environment. High acceleration torques and fast speeds in turns are easily absorbed by the breaker. The specialist for fast e-bikes and rental bikes.



Suitable for E-Bikes: For our E-Bike tire we fall back on over 100 years' experience with moped and motorcycle tires. All of our city/trekking tires are rated to a standard speed of at least 25 km/h. Those tires marked E50 are also certified for S-Pedelecs. With their high quality structure, puncture protection is high and the rolling resistance is low offering protection from premature wear brought about by the additional driving force.



CONTACT Plus City



TECHNOLOGY



SIZES

CONTACT Plus City

SafetyPlus Breaker - 3/180 TPI -

E50 **7**

Article	ETRTO	Dimension	Color/sidewall	g	PSI	kg+	EAN	RRP/€
0101331	47-559	26 x 1.75	● Wire refl.	1000	45-58	109	4 019238 760934	44,95
0101334	55-559	26 x 2.20	● Wire refl.	1230	45-58	121	4 019238 760996	44,95
0101335	55-584	27.5 x 2.20	● Wire refl.	1270	45-58	128	4 019238 761009	44,95
0101336	37-622	28 x 1 $\frac{3}{8}$ x 1 $\frac{5}{8}$	● Wire refl.	900	56-87	95	4 019238 760873	44,95
0101340	42-622	28 x 1.60	● Wire refl.	990	50-73	100	4 019238 760903	44,95
0101343	47-622	28 x 1.75	● Wire refl.	1130	45-58	95	4 019238 760965	44,95

Safety

SAFETY LEVEL **1** **2** **3** **4** **5** **6** **7**



CONTACT



TECHNOLOGY



SIZES



WHEN THINGS GET TOUGH

Versatile allrounder which connects reliably to every surface. Equipped with the most popular tread pattern from the urban/tour range, especially designed for a high degree of safety thanks to its lamellar structure.



TECHNOLOGY

Safety **System**

The **SafetySystem Breaker** consists of a Kevlar-reinforced, high-strength nylon fabric. Puncture and cut resistant, whilst also being light and flexible, allowing the tire to adapt more effectively to the terrain. The breaker protects the carcass against foreign objects and contributes to a longer lifespan of the tire without significantly increasing weight or rolling resistance. Additionally, tires with SafetySystem have particularly comfortable handling characteristics.



Suitable for E-Bikes: For our E-Bike tire we fall back on over 100 years' experience with moped and motorcycle tires. All of our city/trekking tires are rated to a standard speed of at least 25 km/h. Those tires marked E50 are also certified for S-Pedelecs. With their high quality structure, puncture protection is high and the rolling resistance is low offering protection from premature wear brought about by the additional driving force.



SIZES



CONTACT

SafetySystem Breaker - 3/180 TPI - **E25**  **4**

Article	ETRTO	Dimension	Color/sidewall	g	PSI	EAN	RRP/€
0101310	37-406	20 x 1.40	● Wire.	420	56-70	4 019238 760286	18,95
0101311	37-406	20 x 1.40	● Wire refl.	420	56-70	4 019238 760279	19,95
0101312	47-406	20 x 1.75	● Wire	505	45-58	4 019238 761283	18,95
0101313	47-406	20 x 1.75	● Wire refl.	505	45-58	4 019238 761276	19,95
0101314	47-559	26 x 1.75	● Wire	670	45-58	4 019238 761306	30,95
0101315	47-559	26 x 1.75	● Wire refl.	670	45-58	4 019238 761290	34,95
0101316	28-622	28 x 1½ x 1½	● Wire	480	80-102	4 019238 761375	30,95
0101317	28-622	28 x 1½ x 1½	● Wire refl.	480	80-102	4 019238 761368	34,95
0101318	32-622	28 x 1¼ x 1¾	● Wire	495	70-85	4 019238 761320	30,95
0101319	32-622	28 x 1¼ x 1¾	● Wire refl.	495	70-85	4 019238 761313	34,95
0101321	37-622	28 x 1¾ x 1½	● Wire	610	58-85	4 019238 761344	30,95
0101320	37-622	28 x 1¾ x 1½	● Wire refl.	610	58-85	4 019238 761351	34,95
0101325	42-622	28 x 1.60	● Wire	645	51-85	4 019238 761382	30,95
0101324	42-622	28 x 1.60	● Wire refl.	645	51-85	4 019238 761399	34,95
0101327	47-622	28 x 1.75	● Wire	770	45-58	4 019238 761429	30,95
0101328	47-622	28 x 1.75	● Wire refl.	770	45-58	4 019238 761412	34,95

Safety System

SAFETY LEVEL



1

2

3

4

5

6

7



TECHNOLOGY



SIZES



CONTACT Urban



TECHNOLOGY



SIZES

35-349 - 62-584



SIZES

28-622 - 62-622



CYCLING ON THE CITY PULSE

Premium mobility for design enthusiasts. Urban tread pattern packed with the latest technology. The perfect symbiosis between light-rolling and puncture protection reflected in this specialized tire designed for the city jungle.



TECHNOLOGY



SIZES

35-349 - 62-584



SIZES

28-622 - 62-622



PureGrip Compound is derived from an activated Silica compound and is a good example of how we integrate customer feedback continuously into our research and development. This mixture technology fits in perfectly alongside the BlackChili Compound. The name PureGrip does exactly what it says; exceptionally good grip and durability are the distinguishing features of this compound. Engineered with PureGrip in our Performance products in our road and mountain bike ranges.

SafetyPro

The **SafetyPro Breaker** is designed from nylon textile. Cross-woven textile fiber netting that is simultaneously robust and flexible. Maximum puncture protection with minimal added weight. The risk of punctures resulting from glass or sharp stones is substantially reduced.



Suitable for E-Bikes: For our E-Bike tire we fall back on over 100 years' experience with moped and motorcycle tires. All of our city/trekking tires are rated to a standard speed of at least 25 km/h. Those tires marked E50 are also certified for S-Pedelecs. With their high quality structure, puncture protection is high and the rolling resistance is low offering protection from premature wear brought about by the additional driving force.



CONTACT Urban



TECHNOLOGY



SIZES

35-349 - 62-584



SIZES

28-622 - 62-622

CONTACT Urban

PureGrip Compound - SafetyPro - 3/180 TPI

E50

Article	ETRTO	Dimension	Color/sidewall	g	PSI	kg+	EAN	RRP/€
0150681	35-349	16 x 1.35	foldable refl.	205	65-116	71	4 019238 065886	49,95
0150567	35-349	16 x 1.35	Wire refl.	265	65-116	71	4 019238 052749	39,95
0150648	35-349	16 x 1.35	foldable	200	65-116	71	4 019238 063882	44,95
0150649	35-349	16 x 1.35	foldable	200	65-116	71	4 019238 063875	44,95
0150365	32-406	20 x 1.25	Wire refl.	290	65-102	71	4 019238 023152	34,95
0150352	42-406	20 x 1.60	Wire refl.	350	58-87	75	4 019238 021868	34,95
0150354	50-406	20 x 2.00	Wire refl.	430	51-73	80	4 019238 021912	34,95
0150366	47-559	26 x 1.75	Wire refl.	560	44-73	112	4 019238 023145	34,95
0150355	50-559	26 x 2.00	Wire refl.	590	51-73	121	4 019238 021929	34,95
0150367	55-559	26 x 2.20	Wire refl.	665	36-65	132	4 019238 023138	34,95
0150353	42-584	27.5 x 1.60	Wire refl.	510	58-94	106	4 019238 021936	34,95
0150357	50-584	27.5 x 2.00	Wire refl.	615	36-73	121	4 019238 021943	34,95
0150368	55-584	27.5 x 2.20	Wire refl.	690	36-65	132	4 019238 023121	34,95
0150658	62-584	27.5 x 2.50	Wire refl.	740	44-58	132	4 019238 063912	34,95

PURE GRIP
COMPOUND

Safety Pro

E50

SAFETY LEVEL



1

2

3

4

5

6

7



CONTACT Urban



TECHNOLOGY



SIZES

35-349 - 62-584



SIZES

28-622 - 62-622

CONTACT Urban

PureGrip Compound - SafetyPro - 3/180 TPI

E50 **6**

Article	ETRTO	Dimension	Color/sidewall	g	PSI	kg+	EAN	RRP/€
0150369	28-622	28 x 1 $\frac{1}{8}$ x 1 $\frac{1}{8}$	● Wire refl.	400	80-109	85	4 019238 023114	34,95
0150370	32-622	28 x 1 $\frac{1}{4}$ x 1 $\frac{3}{4}$	● Wire refl.	440	65-94	90	4 019238 023107	34,95
0150371	35-622	28 x 1 $\frac{3}{8}$ x 1 $\frac{5}{8}$	● Wire refl.	460	65-94	95	4 019238 023091	34,95
0150350	37-622	28 x 1 $\frac{3}{8}$ x 1 $\frac{5}{8}$	● Wire refl.	480	58-94	100	4 019238 021875	34,95
0150351	40-622	28 x 1.50	● Wire refl.	540	58-94	100	4 019238 021882	34,95
0150349	42-622	28 x 1.60	● Wire refl.	640	51-87	106	4 019238 021899	34,95
0150372	47-622	28 x 1.75	● Wire refl.	620	44-73	115	4 019238 023084	34,95
0150358	50-622	28 x 2.00	● Wire refl.	655	51-73	121	4 019238 021950	34,95
0150373	55-622	28 x 2.20	● Wire refl.	735	36-65	132	4 019238 023077	34,95
0150656	62-622	28 x 2.50	● Wire refl.	785	44-58	132	4 019238 063936	34,95

PURE GRIP
COMPOUNDSafety **Pro**

E50

SAFETY LEVEL



1

2

3

4

5

6

7



CONTACT Speed



TECHNOLOGY



SIZES WIRE



SIZES WIRE REFLEX



UNITES SPEED AND COMFORT IN ONE TIRE

The perfect choice for the city speedsters, single-speed bikes and fitness bikes. With its double layer of fabric breaker, the light-weight design and its roughened slick tread it shines especially on tarmac.



TECHNOLOGY



SIZES WIRE



SIZES WIRE REFLEX

Safety **System**

The **SafetySystem Breaker** consists of a Kevlar-reinforced, high-strength nylon fabric. Puncture and cut resistant, whilst also being light and flexible, allowing the tire to adapt more effectively to the terrain. The breaker protects the carcass against foreign objects and contributes to a longer lifespan of the tire without significantly increasing weight or rolling resistance. Additionally, tires with SafetySystem have particularly comfortable handling characteristics.



Suitable for E-Bikes: For our E-Bike tire we fall back on over 100 years' experience with moped and motorcycle tires. All of our city/trekking tires are rated to a standard speed of at least 25 km/h. Those tires marked E50 are also certified for S-Pedelecs. With their high quality structure, puncture protection is high and the rolling resistance is low offering protection from premature wear brought about by the additional driving force.



CONTACT Speed



TECHNOLOGY



SIZES WIRE



SIZES WIRE REFLEX

CONTACT Speed

SafetySystem Breaker - 3/180 TPI -

E25 **4**

Article	ETRTO	Dimension	Color/sidewall	g	PSI	EAN	RRP/€
0101387	28-406	20 x 1.10	● Wire	265	70-87	4 019238 774665	20,95
0101389	32-559	26 x 1.30	● Wire	430	70-85	4 019238 774658	30,95
0101393	42-559	26 x 1.60	● Wire	540	65-85	4 019238 774641	30,95
0101395	50-559	26 x 2.00	● Wire	665	45-58	4 019238 774634	30,95
0101397	32-584	27.5 x 1.25	● Wire	470	70-85	4 019238 774535	30,95
0101401	50-584	27.5 x 2.00	● Wire	700	50-65	4 019238 774627	30,95
0101402	28-622	28 x 1 $\frac{5}{8}$ x 1 $\frac{1}{8}$	● Wire	425	80-102	4 019238 774610	30,95
0101406	32-622	28 x 1 $\frac{1}{4}$ x 1 $\frac{3}{4}$	● Wire	485	70-85	4 019238 774597	30,95
0101412	37-622	28 x 1 $\frac{3}{8}$ x 1 $\frac{5}{8}$	● Wire	500	70-85	4 019238 774559	30,95
0101416	42-622	28 x 1.60	● Wire	590	50-87	4 019238 774504	30,95

Safety System

SAFETY LEVEL



1

2

3

4

5

6

7





TECHNOLOGY



SIZES WIRE



SIZES WIRE REFLEX

CONTACT Speed

SafetySystem Breaker - 3/180 TPI -

E25 **4**

Article	ETRTO	Dimension	Color/sidewall	g	PSI	EAN	RRP/€
0101388	28-406	20 x 1.10	● Wire refl.	265	70-87	4 019238 774481	24,95
0101391	32-559	26 x 1.30	● Wire refl.	430	70-85	4 019238 774474	34,95
0101392	42-559	26 x 1.60	● Wire refl.	540	65-85	4 019238 774467	34,95
0101396	50-559	26 x 2.00	● Wire refl.	665	45-58	4 019238 774450	34,95
0101399	50-584	27.5 x 2.00	● Wire refl.	700	50-65	4 019238 774443	34,95
0101403	28-622	28 x 1 $\frac{1}{8}$ x 1 $\frac{1}{8}$	● Wire refl.	425	80-102	4 019238 774436	34,95
0101408	32-622	28 x 1 $\frac{1}{4}$ x 1 $\frac{3}{4}$	● Wire refl.	485	70-85	4 019238 774429	34,95
0101414	37-622	28 x 1 $\frac{3}{8}$ x 1 $\frac{5}{8}$	● Wire refl.	500	70-85	4 019238 774405	34,95
0101418	42-622	28 x 1.60	● Wire refl.	590	50-87	4 019238 774382	34,95

Safety **System**

SAFETY LEVEL



1

2

3

4

5

6

7



CONTACT Spike 120 and 240



TECHNOLOGY



SIZES



CONTACT Spike 120 and 240

OUR RECOMMENDATION FOR SNOW AND ICE

Safety during cold and dark seasons: The spikes guarantee traction, the reflective stripes ensure visibility. Maintain full control of your bicycle even in turns and hard stops. Choose between 120 or 240 spikes.



TECHNOLOGY

Safety System

The **SafetySystem Breaker** consists of a Kevlar-reinforced, high-strength nylon fabric. Puncture and cut resistant, whilst also being light and flexible, allowing the tire to adapt more effectively to the terrain. The breaker protects the carcass against foreign objects and contributes to a longer lifespan of the tire without significantly increasing weight or rolling resistance. Additionally, tires with SafetySystem have particularly comfortable handling characteristics.



Suitable for E-Bikes: For our E-Bike tire we fall back on over 100 years' experience with moped and motorcycle tires. All of our city/trekking tires are rated to a standard speed of at least 25 km/h. Those tires marked E50 are also certified for S-Pedelecs. With their high quality structure, puncture protection is high and the rolling resistance is low offering protection from premature wear brought about by the additional driving force.



SIZES



CONTACT Spike 120 and 240



TECHNOLOGY



SIZES

CONTACT Spike 120

SafetySystem Breaker - 3/180 TPI -

E25 **4**

Article	ETRTO	Dimension	Color/sidewall	g	PSI	EAN	RRP/€
0150498	32-622	28 x 1¼ x 1¾	● Wire refl.	635	65-94	4 019238 034868	44,95
0150269	37-622	28 x 1½ x 1½	● Wire refl.	715	56-73	4 019238 779622	44,95
0150268	42-622	28 x 1.60	● Wire refl.	870	50-87	4 019238 779639	44,95

Safety **System**



CONTACT Spike 240

SafetySystem Breaker - 3/180 TPI -

E25 **4**

Article	ETRTO	Dimension	Color/sidewall	g	PSI	EAN	RRP/€
0150091	37-622	28 x 1½ x 1½	● Wire refl.	715	56-73	4 019238 610345	57,95
0150191	42-622	28 x 1.60	● Wire refl.	870	50-87	4 019238 682267	57,95

Safety **System**



SAFETY LEVEL



1

2

3

4

5

6

7



Top CONTACT II



TECHNOLOGY



SIZES



THE FAST PREMIUM ALL-ROUNDER

Premium-allrounder: Riding fast and safe on the road, gravel or forest paths. Outstanding rolling characteristics fostered by a broad central tread pattern and a high-end fabric breaker.



TECHNOLOGY

Vectran™
BREAKER

Vectran is spun from liquid crystal-polymer. This way a thermoplastic, multiple-thread yarn is created. As a comparison: This partially crystalline fabric is more cut-resistant than aramide and its tensile strength is five times higher than that of steel. A Vectran breaker is lighter, more flexible and effective against cuts than a comparable nylon breaker. Without effecting rolling resistance.



SIZES



Suitable for E-Bikes: For our E-Bike tire we fall back on over 100 years' experience with moped and motorcycle tires. All of our city/trekking tires are rated to a standard speed of at least 25 km/h. Those tires marked E50 are also certified for S-Pedelecs. With their high quality structure, puncture protection is high and the rolling resistance is low offering protection from premature wear brought about by the additional driving force.



Top CONTACT II

Top CONTACT II

Vectran Breaker - 3/180 TPI - **E50**  **6**

Article	ETRTO	Dimension	Color/sidewall	g	PSI	kg+	EAN	RRP/€
0101735	50-559	26 x 2.00	● foldable refl.	715	44-65	109	4 019238 031812	62,95
0100615	28-622	28 x 1 $\frac{1}{8}$ x 1 $\frac{1}{8}$	● foldable refl.	455	80-102	85	4 019238 576924	62,95
0100573	32-622	28 x 1 $\frac{1}{4}$ x 1 $\frac{3}{4}$	● foldable refl.	510	70-85	85	4 019238 050318	62,95
0100441	37-622	28 x 1 $\frac{3}{8}$ x 1 $\frac{5}{8}$	● foldable refl.	590	73-85	85	4 019238 521627	62,95
0100358	42-622	28 x 1.60	● foldable refl.	725	58-85	85	4 019238 500240	62,95
0100439	47-622	28 x 1.75	● foldable refl.	745	45-65	95	4 019238 521603	62,95

Vectran™
BREAKER 

TECHNOLOGY



SIZES

SAFETY LEVEL



1

2

3

4

5

6

7



Top CONTACT Winter II Prem.



TECHNOLOGY



SIZES



THE PREMIUM WINTER TIRE

The Top CONTACT Winter II Premium benefits from our know-how as leading manufacturer of winter tires for cars and trucks and offers full control on slippery, snowy roads and surfaces thanks to its grippy lamellar tread pattern.



TECHNOLOGY



Vectran is spun from liquid crystal-polymer. This way a thermoplastic, multiple-thread yarn is created. As a comparison: This partially crystalline fabric is more cut-resistant than aramide and its tensile strength is five times higher than that of steel. A Vectran breaker is lighter, more flexible and effective against cuts than a comparable nylon breaker. Without effecting rolling resistance.



SIZES



Suitable for E-Bikes: For our E-Bike tire we fall back on over 100 years' experience with moped and motorcycle tires. All of our city/trekking tires are rated to a standard speed of at least 25 km/h. Those tires marked E50 are also certified for S-Pedelecs. With their high quality structure, puncture protection is high and the rolling resistance is low offering protection from premature wear brought about by the additional driving force.



Top CONTACT Winter II Prem.

Top CONTACT Winter II Premium

Vectran Breaker - 3/180 TPI - 

E50

6

Article	ETRTO	Dimension	Color/sidewall	g	PSI	kg+	EAN	RRP/€
0100712	50-559	26 x 1.90	● foldable refl.	610	45-58	121	4 019238 586275	67,95
0101734	55-559	26 x 2.20	● foldable refl.	755	45-58	128	4 019238 031836	67,95
0101281	50-584	27.5 x 2.00	● foldable refl.	640	44-65	121	4 019238 733297	67,95
0100713	37-622	28 x 1 $\frac{3}{8}$ x 1 $\frac{5}{8}$	● foldable refl.	470	73-85	95	4 019238 586268	67,95
0100714	42-622	28 x 1.60	● foldable refl.	685	58-87	100	4 019238 586251	67,95



TECHNOLOGY



SIZES



SAFETY LEVEL



1

2

3

4

5

6

7



Urban Taraxagum



TECHNOLOGY



SIZES

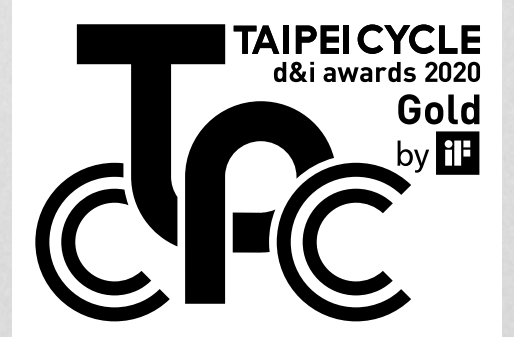

GIVE SOMETHING BACK TO YOUR CITY!

The Urban Taraxagum is the first serial product made of dandelion rubber combining local production with minimal transport distances in the supply chain – ideal for the urban ride.



TECHNOLOGY

Vectran™
BREAKER

Vectran is spun from liquid crystal-polymer. This way a thermoplastic, multiple-thread yarn is created. As a comparison: This partially crystalline fabric is more cut-resistant than aramide and its tensile strength is five times higher than that of steel. A Vectran breaker is lighter, more flexible and effective against cuts than a comparable nylon breaker. Without effecting rolling resistance.



SIZES

TARAXA GUM 

The Urban Taraxagum by Continental is the first serial bicycle tire made from dandelion rubber, for which we established the brand **Taraxagum**. The project is embedded in a comprehensive sustainability strategy, covering economic, ecological and social aspects. Through significantly shorter distances from the fields and our European tire plants we reduce efforts in logistics and transport and use resources more efficiently.



Urban Taraxagum

Urban Taraxagum

Taraxagum - Vectran Breaker - 3/180 TPI

Article	ETRTO	Dimension	Color/sidewall	g	PSI	EAN	RRP/€
0101675	35-622	28 x 1 3/8 x 1 5/8	● foldable	345	65-85	4 019238 023046	69,95



TECHNOLOGY



SIZES



Funded by the European Union by the operational program of the ERDF during the 2014-2020 funding period



Best of Northern Germany

Supported by:



Federal Ministry of Education and Research

on the basis of a decision by the German Bundestag

Supported by:



Federal Ministry of Food and Agriculture

on the basis of a decision by the German Bundestag



Super Sport Plus



TECHNOLOGY



SIZES



FIXIE OR RACING BIKE? SUPER FAST AND SUPER RELIABLE FROM A TO B

Fast on tarmac and bicycle paths with its special slick tread pattern. Longevity and high puncture protection are the main focus. A reliable companion also for newcomers to cycling.



TECHNOLOGY



SIZES

Super Sport Plus

Plus Breaker - 3/84 TPI

Article	ETRTO	Dimension	Color/sidewall	g	PSI	EAN	RRP/€
0100341	23-622	700 x 23C	● foldable	380	110-120	4 019238 470512	33,95
0100344	23-622	700 x 23C	● Wire	440	110-120	4 019238 470550	28,95
0100343	25-622	700 x 25C	● foldable	425	95-120	4 019238 470536	33,95
0100342	25-622	700 x 25C	● Wire	485	95-120	4 019238 470529	28,95
0100349	28-622	700 x 28C	● Wire	565	80-116	4 019238 486278	28,95
0100347	28-630	27 x 1½	● Wire	590	80-116	4 019238 486254	28,95
0100348	32-630	27 x 1¼	● Wire	635	70-102	4 019238 486261	28,95



RIDE Tour



TECHNOLOGY



SIZES WIRE



SIZES WIRE REFLEX



A LOYAL COMPANION ON YOUR REGULAR RIDES

Tarmac, gravel, urban environment - the right tire for your daily ride thanks to robust puncture protection and an additional rubber layer for high milage. Available in a large range of colors and sizes.



TECHNOLOGY



SIZES WIRE



SIZES WIRE REFLEX



Anyone looking for a reliable everyday companion will go for a tire with **EXTRA PunctureBelt**. This rugged rubber breaker, combined with the rubber-reinforced sidewalls of the tire, ensures a high level of puncture protection and sidewall abrasion. Where durability is the main focus, there is also a solid tire version.



Suitable for E-Bikes: For our E-Bike tire we fall back on over 100 years' experience with moped and motorcycle tires. All of our city/trekking tires are rated to a standard speed of at least 25 km/h. Those tires marked E50 are also certified for S-Pedelecs. With their high quality structure, puncture protection is high and the rolling resistance is low offering protection from premature wear brought about by the additional driving force.





TECHNOLOGY



SIZES WIRE



SIZES WIRE REFLEX

RIDE Tour

ExtraPuncture Belt - 3/180 TPI

E25

Article	ETRTO	Dimension	Col./side	g	PSI	EAN	RRP/€	Article	ETRTO	Dimension	Col./side	g	PSI	EAN	RRP/€
0101137	62-203	12½ x 2¼	● Wire	405	45-58	4 019238 693645	14,95	0101188	32-622	28 x 1¼ x 1¾	◐ Wire	600	70-80	4 019238 694703	22,95
0101138	47-305	16 x 1.75	● Wire	490	45-58	4 019238 693638	14,95	0101155	37-622	28 x 1¾ x 1¾	● Wire	690	56-70	4 019238 693485	22,95
0101140	47-406	20 x 1.75	● Wire	600	45-58	4 019238 693614	14,95	0101180	37-622	28 x 1¾ x 1¾	◑ Wire	725	56-70	4 019238 694673	22,95
0101184	47-406	20 x 1.75	◐ Wire	630	45-58	4 019238 694741	14,95	0101193	37-622	28 x 1¾ x 1¾	◐ Wire	725	56-70	4 019238 694734	22,95
0101143	47-507	24 x 1.75	● Wire	720	45-58	4 019238 693591	16,95	0101177	37-622	28 x 1¾ x 1¾	◑ Wire	725	56-70	4 019238 694581	22,95
0101186	47-507	24 x 1.75	◐ Wire	810	45-58	4 019238 694758	16,95	0101157	42-622	28 x 1.60	● Wire	790	51-65	4 019238 693478	22,95
0101148	47-559	26 x 1.75	● Wire	780	45-58	4 019238 693553	22,95	0101159	47-622	28 x 1.75	● Wire	900	45-58	4 019238 693461	22,95
0101181	47-559	26 x 1.75	◑ Wire	870	45-58	4 019238 694680	22,95	0101179	47-622	28 x 1.75	◑ Wire	960	45-58	4 019238 694697	22,95
0101189	47-559	26 x 1.75	◐ Wire	870	45-58	4 019238 694765	22,95	0101194	47-622	28 x 1.75	◐ Wire	960	45-58	4 019238 694772	22,95
0101187	37-584	26/27.5 x 1¾	◐ Wire	690	56-70	4 019238 694727	22,95	0101185	47-622	28 x 1.75	● Wire	960	45-58	4 019238 694642	22,95
0101146	42-584	26/27.5 x 1½	● Wire	720	51-65	4 019238 693577	22,95	0101161	32-630	27 x 1¼	● Wire	660	70-80	4 019238 693447	22,95
0101150	54-584	26/27.5 x 1½ x 2	● Wire	950	45-58	4 019238 693539	22,95	0101183	32-630	27 x 1¼	◐ Wire	610	70-80	4 019238 694710	22,95
0101433	37-609	27 x 1¾ x 1½	● Wire	685	56-70	4 019238 781823	22,95	0101164	37-635	28 x 1¾	● Wire	710	56-70	4 019238 693416	22,95
0101151	28-622	28 x 1¾ x 1¾	● Wire	540	70-102	4 019238 693522	22,95	0101165	42-635	28 x 1½	● Wire	820	51-65	4 019238 693409	22,95
0101153	32-622	28 x 1¼ x 1¾	● Wire	640	70-80	4 019238 693508	22,95								



SAFETY LEVEL



1

2

3

4

5

6

7





TECHNOLOGY



SIZES WIRE



SIZES WIRE REFLEX

RIDE Tour

ExtraPuncture Belt - 3/180 TPI

E25

Article	ETRTO	Dimension	Col./side	g	PSI	EAN	RRP/€	Article	ETRTO	Dimension	Col./side	g	PSI	EAN	RRP/€
0101139	47-305	16 x 1.75	Wire refl.	490	45-58	4 019238 693621	16,95	0101156	37-622	28 x 1 $\frac{3}{8}$ x 1 $\frac{3}{8}$	Wire refl.	690	56-70	4 019238 692549	24,95
0101142	47-406	20 x 1.75	Wire refl.	600	45-58	4 019238 693607	18,95	0101182	37-622	28 x 1 $\frac{3}{8}$ x 1 $\frac{3}{8}$	Wire refl.	725	56-70	4 019238 694598	24,95
0101144	47-507	24 x 1.75	Wire refl.	720	45-58	4 019238 693584	18,95	0101167	42-622	28 x 1.60	Wire refl.	790	50-65	4 019238 693386	24,95
0101149	47-559	26 x 1.75	Wire refl.	780	45-58	4 019238 693546	24,95	0101176	42-622	28 x 1.60	Wire refl.	790	50-65	4 019238 694611	24,95
0101175	47-559	26 x 1.75	Wire refl.	870	45-58	4 019238 694628	24,95	0101160	47-622	28 x 1.75	Wire refl.	900	45-58	4 019238 693454	24,95
0101147	42-584	26/27.5 x 1 $\frac{1}{2}$	Wire refl.	720	50-65	4 019238 693560	24,95	0101162	32-630	27 x 1 $\frac{1}{4}$	Wire refl.	660	70-80	4 019238 693430	24,95
0101168	54-584	26/27.5 x 1 $\frac{1}{2}$ x 2	Wire refl.	720	50-65	4 019238 693379	24,95	0101164	37-635	28 x 1 $\frac{3}{8}$	Wire refl.	710	56-70	4 019238 693416	24,95
0101152	28-622	28 x 1 $\frac{1}{8}$ x 1 $\frac{1}{8}$	Wire refl.	540	70-102	4 019238 693515	24,95	0101166	42-635	28 x 1 $\frac{1}{2}$	Wire refl.	820	50-65	4 019238 693393	24,95
0101154	32-622	28 x 1 $\frac{1}{4}$ x 1 $\frac{1}{4}$	Wire refl.	640	70-80	4 019238 693492	24,95								



SAFETY LEVEL



1

2

3

4

5

6

7





TECHNOLOGY



SIZES



A ROBUST TIRE WITH A MODERN LOOK

High reliability and always on time in urban traffic: Solid tire for city bikes. Proven successful on tarmac as well as on gravel thanks to good traction provided by its broad contact area in the tread pattern.



TECHNOLOGY



Anyone looking for a reliable everyday companion will go for a tire with **EXTRA PunctureBelt**. This rugged rubber breaker, combined with the rubber-reinforced sidewalls of the tire, ensures a high level of puncture protection and sidewall abrasion. Where durability is the main focus, there is also a solid tire version.



SIZES













Suitable for E-Bikes: For our E-Bike tire we fall back on over 100 years' experience with moped and motorcycle tires. All of our city/trekking tires are rated to a standard speed of at least 25 km/h. Those tires marked E50 are also certified for S-Pedelecs. With their high quality structure, puncture protection is high and the rolling resistance is low offering protection from premature wear brought about by the additional driving force.













RIDE City

ExtraPuncture Belt - 3/180 TPI

E25 

Article	ETRTO	Dimension	Col./side	g	PSI	EAN	RRP/€
0101552	47-559	26 x 1.75	 Wire refl.	940	45-58	4 019238 810431	24,95
0101652	47-559	26 x 1.75	 Wire refl.	960	45-58	4 019238 012514	24,95
0101651	47-559	26 x 1.75	 Wire refl.	930	45-58	4 019238 012521	24,95
0101553	32-622	28 x 1¼ x 1¼	 Wire refl.	700	70-80	4 019238 810424	24,95
0101554	37-622	28 x 1¾ x 1¾	 Wire refl.	850	51-65	4 019238 810417	24,95
0101603	37-622	28 x 1¾ x 1¾	 Wire refl.	850	51-65	4 019238 005349	24,95
0101604	37-622	28 x 1¾ x 1¾	 Wire refl.	850	51-65	4 019238 005356	24,95
0101650	37-622	28 x 1¾ x 1¾	 Wire refl.	820	51-65	4 019238 012507	24,95
0101649	37-622	28 x 1¾ x 1¾	 Wire refl.	820	51-65	4 019238 012538	24,95
0101555	42-622	28 x 1.60	 Wire refl.	950	50-65	4 019238 810400	24,95
0101605	42-622	28 x 1.60	 Wire refl.	950	50-65	4 019238 005363	24,95

Article	ETRTO	Dimension	Col./side	g	PSI	EAN	RRP/€
0101657	42-622	28 x 1.60	 Wire refl.	950	50-65	4 019238 017106	24,95
0101648	42-622	28 x 1.60	 Wire refl.	950	50-65	4 019238 012545	24,95
0101647	42-622	28 x 1.60	 Wire refl.	950	50-65	4 019238 012552	24,95
0101556	47-622	28 x 1.75	 Wire refl.	1100	45-58	4 019238 810394	24,95
0101607	47-622	28 x 1.75	 Wire refl.	1100	45-58	4 019238 005387	24,95
0101679	47-622	28 x 1.75	 Wire refl.	1100	45-58	4 019238 023244	24,95
0101658	47-622	28 x 1.75	 Wire refl.	1160	45-58	4 019238 017090	24,95
0101608	47-622	28 x 1.75	 Wire refl.	1100	45-58	4 019238 005394	24,95
0101646	47-622	28 x 1.75	 Wire refl.	1050	45-58	4 019238 012569	24,95
0101645	47-622	28 x 1.75	 Wire refl.	1050	45-58	4 019238 012576	24,95



TECHNOLOGY



SIZES



SAFETY LEVEL



1

2

3

4

5

6

7



Competition

Competition TT

Sprinter

Sprinter Gatorskin

Sonderklasse II

Tempo II

Giro



TUBULAR

Competition



TECHNOLOGY



SIZES



IT'S TIME TO RACE: THE CLASSIC FOR STRONG ACCELERATION

Robust all-rounder appearing at the sharp end in all the major cycling races around the world. Agile and fast, adapts to the competition in all road conditions.



TECHNOLOGY



With our unique tread compound, we have revolutionized the sport of cycling. With the legendary **BlackChili Compound** we have answered the eternal question of the best balance of grip and rolling resistance for cycling. The latest polymers as well as specially developed carbon black particles and filler materials guarantee unique performance, be it on a road, gravel or a mountain bike, for time trialling or downhill.



Vectran is spun from liquid crystal-polymer. This way a thermoplastic, multiple-thread yarn is created. As a comparison: This partially crystalline fabric is more cut-resistant than aramide and its tensile strength is five times higher than that of steel. A Vectran breaker is lighter, more flexible and effective against cuts than a comparable nylon breaker. Without effecting rolling resistance.



SIZES





TECHNOLOGY



SIZES

Competition

 BlackChili Compound - Vectran Breaker - 3/180 TPI

Article	Dimension	Color/sidewall	g	PSI	EAN	RRP/€
0196140	28 x 19	● Tubular	200	145-170	4 019238 334753	119,95
0196138	28 x 22	● Tubular	235	115-170	4 019238 334760	119,95
0196189	28 x 25	● Tubular	250	115-170	4 019238 549126	119,95



Competition TT



TECHNOLOGY



SIZES



EVEN FASTER

Even faster time trial tire due to the delicate carcass.
Excellent acceleration thanks to the application of a latex tube.
Design updated to a smooth central tread pattern.

! Please consider the special attributes of latex tubes.



TECHNOLOGY



With our unique tread compound, we have revolutionized the sport of cycling. With the legendary **BlackChili Compound** we have answered the eternal question of the best balance of grip and rolling resistance for cycling. The latest polymers as well as specially developed carbon black particles and filler materials guarantee unique performance, be it on a road, gravel or a mountain bike, for time trialling or downhill.



Vectran is spun from liquid crystal-polymer. This way a thermoplastic, multiple-thread yarn is created. As a comparison: This partially crystalline fabric is more cut-resistant than aramide and its tensile strength is five times higher than that of steel. A Vectran breaker is lighter, more flexible and effective against cuts than a comparable nylon breaker. Without effecting rolling resistance.



SIZES



Competition TT

Competition TT

BlackChili Compound - Vectran Breaker - 3/180 TPI

Article	Dimension	Color/sidewall	g	PSI	EAN	RRP/€
0196270	28 x 25	● Tubular	190	115-170	4 019238 043884	119,95



TECHNOLOGY



SIZES



Sprinter



TECHNOLOGY



SIZES



FAST SPRINTER, FOR WINNING THE POINTS

Efficient tires for criteriums or triathlon where the tires winning characteristics will shine through. Neutral slick profile for a direct feel with the road. Full speed ahead!



TECHNOLOGY



With our unique tread compound, we have revolutionized the sport of cycling. With the legendary **BlackChili Compound** we have answered the eternal question of the best balance of grip and rolling resistance for cycling. The latest polymers as well as specially developed carbon black particles and filler materials guarantee unique performance, be it on a road, gravel or a mountain bike, for time trialling or downhill.



SIZES

Safety System

The **SafetySystem Breaker** consists of a Kevlar-reinforced, high-strength nylon fabric. Puncture and cut resistant, whilst also being light and flexible, allowing the tire to adapt more effectively to the terrain. The breaker protects the carcass against foreign objects and contributes to a longer lifespan of the tire without significantly increasing weight or rolling resistance. Additionally, tires with SafetySystem have particularly comfortable handling characteristics.





TECHNOLOGY



SIZES



Sprinter
 BlackChili Compound - SafetySystem Breaker - 3/180 TPI

Article	Dimension	Color/sidewall	g	PSI	EAN	RRP/€
0196150	26 x 22	● Tubular	265	145-170	4 019238 341034	67,95
0196135	28 x 22	● Tubular	280	115-170	4 019238 334715	67,95
0196244	28 x 25	● Tubular	295	115-170	4 019238 674576	67,95



Sprinter Gatorskin



TECHNOLOGY



SIZES



THE ROBUST SPRINTER, CREATED FOR EXTENDED RIDES AND TRAINING

The roads of Flanders, Roubaix and San Remo are home to this tough tubular. Durable and puncture protected carcass, ready for hundreds of kilometres, even on bad roads.



TECHNOLOGY



With our unique tread compound, we have revolutionized the sport of cycling. With the legendary **BlackChili Compound** we have answered the eternal question of the best balance of grip and rolling resistance for cycling. The latest polymers as well as specially developed carbon black particles and filler materials guarantee unique performance, be it on a road, gravel or a mountain bike, for time trialling or downhill.

Safety System

The **SafetySystem Breaker** consists of a Kevlar-reinforced, high-strength nylon fabric. Puncture and cut resistant, whilst also being light and flexible, allowing the tire to adapt more effectively to the terrain. The breaker protects the carcass against foreign objects and contributes to a longer lifespan of the tire without significantly increasing weight or rolling resistance. Additionally, tires with SafetySystem have particularly comfortable handling characteristics.



Tires with **DuraSkin** sidewall protection can take a beating as they are designed for the most adverse conditions. In rough terrain on a cyclocross or a gravel bike, on commuter bikes where tires scrape along curbs, on touring bikes as they cross continents encountering many different road qualities and on the race circuit where they prove themselves in endurance events such as the Paris-Roubaix. The high-quality polyamide fabric reliably protects the wall of the tire. Tires with DuraSkin[®] can be identified by the characteristic brown mesh sidewall.



SIZES



Sprinter Gatorskin



TECHNOLOGY



SIZES

Sprinter Gatorskin

BlackChili Compound - SafetySystem Breaker - 3/180 TPI

Article	Dimension	Color/sidewall	g	PSI	EAN	RRP/€
0196136	28 x 22	● Tubular	275	115-170	4 019238 334722	72,95
0196187	28 x 25	● Tubular	285	115-170	4 019238 549089	72,95





Sonderklasse II



TECHNOLOGY



SIZES



WITH ITS SINGLE MINDED DESIGN, THE SIX DAY HERO OF THE WOODEN BOARDS

Extremely light and fast handling tire – made for endurance racing on the wooden boards. A special slick profile for the highest speeds puts this tire into a class of its own in our track racing range.



TECHNOLOGY



With our unique tread compound, we have revolutionized the sport of cycling. With the legendary **BlackChili Compound** we have answered the eternal question of the best balance of grip and rolling resistance for cycling. The latest polymers as well as specially developed carbon black particles and filler materials guarantee unique performance, be it on a road, gravel or a mountain bike, for time trialling or downhill.



SIZES



Sonderklasse II

Sonderklasse II

BlackChili Compound - 3/180 TPI

Article	Dimension	Color/sidewall	g	PSI	EAN	RRP/€
0196188	28 x 23	● Tubular	195	160-170	4 019238 549119	129,95



TECHNOLOGY



SIZES



Tempo II



TECHNOLOGY



SIZES



THE VELODROME ALL-ROUNDER FOR ALL TRACK DISCIPLINES

Particularly light and fast racing tire designed for the concrete and wooden surfaces of velodromes. No compromise design: made with a particularly fine carcass and a slightly roughened slick tread.



TECHNOLOGY



With our unique tread compound, we have revolutionized the sport of cycling. With the legendary **BlackChili Compound** we have answered the eternal question of the best balance of grip and rolling resistance for cycling. The latest polymers as well as specially developed carbon black particles and filler materials guarantee unique performance, be it on a road, gravel or a mountain bike, for time trialling or downhill.



SIZES



Tempo II

BlackChili Compound - 3/180 TPI

Article	Dimension	Color/sidewall	g	PSI	EAN	RRP/€
0196185	28 x 19	● Tubular	185	160-220	4 019238 549065	112,95
0196184	28 x 22	● Tubular	200	160-170	4 019238 549058	112,95



TECHNOLOGY



SIZES





TECHNOLOGY



SIZES



FOR NEWCOMERS: THE PERFECT COMPANION FOR TRAINING AND LEISURE RIDES

A reliable all-round tire, high quality for newcomers with high aspirations. High mileage and excellent value for money.



TECHNOLOGY



SIZES

Giro

Performance - 2/160 TPI

Article	Dimension	Color/sidewall	g	PSI	EAN	RRP/€
0196017	28 x 22	 Tubular	390	115-145	4 019238 107715	39,95



ROAD

MTB

GRAVEL

URBAN

Grand Prix 5000



Xynotal

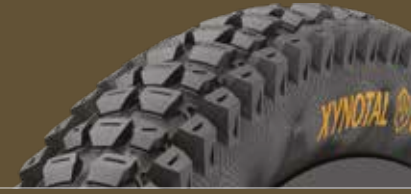

Terra Speed



Pure CONTACT



Ultra Sport III



Kryptotal



Terra Trail



eCONTACT Plus



Argotal



Terra Hardpack



CONTACT Plus



Hydrotal



CONTACT Plus City



Mountain King



CONTACT



Cross King

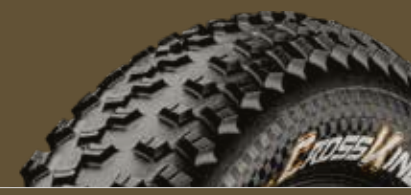

CONTACT Urban



Race King



CONTACT Speed



Ruban | eRuban



CONTACT Spike



Top CONTACT II



Top CONTACT Winter II

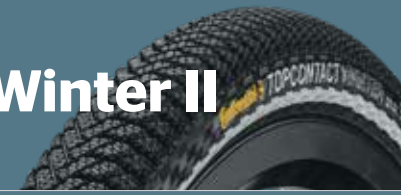

RIDE Tour



RIDE City



Suitable for E-Bikes

For our E-Bike tire we fall back on over 100 years' experience with moped and motorcycle tires. All of our urban/tour tires are rated to a standard speed of at least 25 km/h. Those tires marked E50 are also certified for S-Pedelecs. With their high quality structure, puncture protection is high and the rolling resistance is low offering protection from premature wear brought about by the additional driving force.



BlackChili Compound

PureGrip Compound

PolyX Breaker™

NyTech Breaker

Hardshell Protection

Vectran Breaker

DuraSkin®

SafetyPro Breaker

EXTRA PunctureBelt

Puncture ProTecton

SafetyPlus Breaker

SafetySystem Breaker

SafetyPlus Pro Breaker



TECH

BlackChili Compound

IT'S ALL ABOUT HOW YOU MIX IT

With our unique tread compound, we have revolutionized the sport of cycling. With the legendary BlackChili Compound we have answered the eternal question of the best balance of grip and rolling resistance for cycling. The latest polymers as well as specially developed carbon black particles and filler materials guarantee unique performance, be it on a road, gravel or a mountain bike, for time trialling or downhill.



PURE GRIP FOR EVERYONE

PureGrip Compound is derived from an activated Silica compound and is a good example of how we integrate customer feedback continuously into our research and development. This mixture technology fits in perfectly alongside the BlackChili Compound. The name PureGrip does exactly what it says; exceptionally good grip and durability are the distinguishing features of this compound. Engineered with PureGrip in our Performance products in our road and mountain bike ranges.



CUT AND PUNCTURE PROOF

With PolyX Breaker™ car expertise comes to the bicycle tire sector. Polyester has been used successfully for years in car tires and has proved extremely effective. The extremely resistant polyester fibre is woven tightly crosswise. A very high fabric density is achieved which makes the breaker resistant not only to foreign bodies, but especially to punctures. The rolling resistance is not affected by this breaker.



NyTech Breaker

LIGHT AND SLEEK

The Nytech Breaker is based on the technology of our SafetySystem puncture protection. Made of nylon fibre and similar to Kevlar, it reliably protects against punctures and cuts. It also has particularly low rolling resistance and reduced weight, perfect for our performance range of road tires.

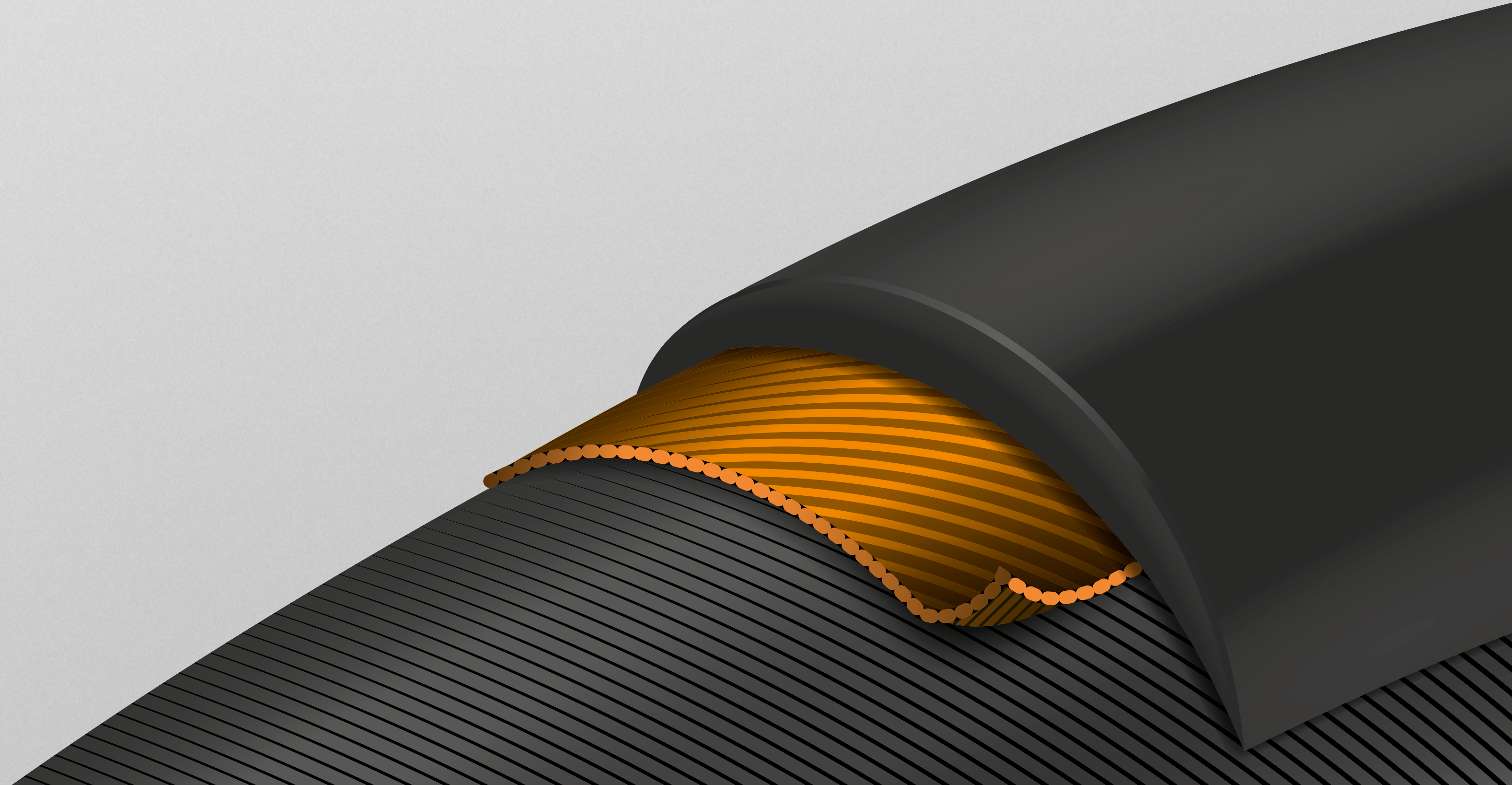

MORE IS WHAT YOU GET

Puncture protection and mileage are the strengths of Hardshell-ProTectio. A wider PolyX Breaker™, the specialist against punctures, under the tread centre and shoulders provides for great reliability. The three-ply - each layer with 60 TPI - carcass covers the entire tire and makes it a real bastion against urban detritus. The outer sidewalls of the tire are reinforced with DuraSkin® fabric providing even more reliability due to the casing being so well protected. Hardshell tires are the puncture-resistant flagship amongst racing tires.

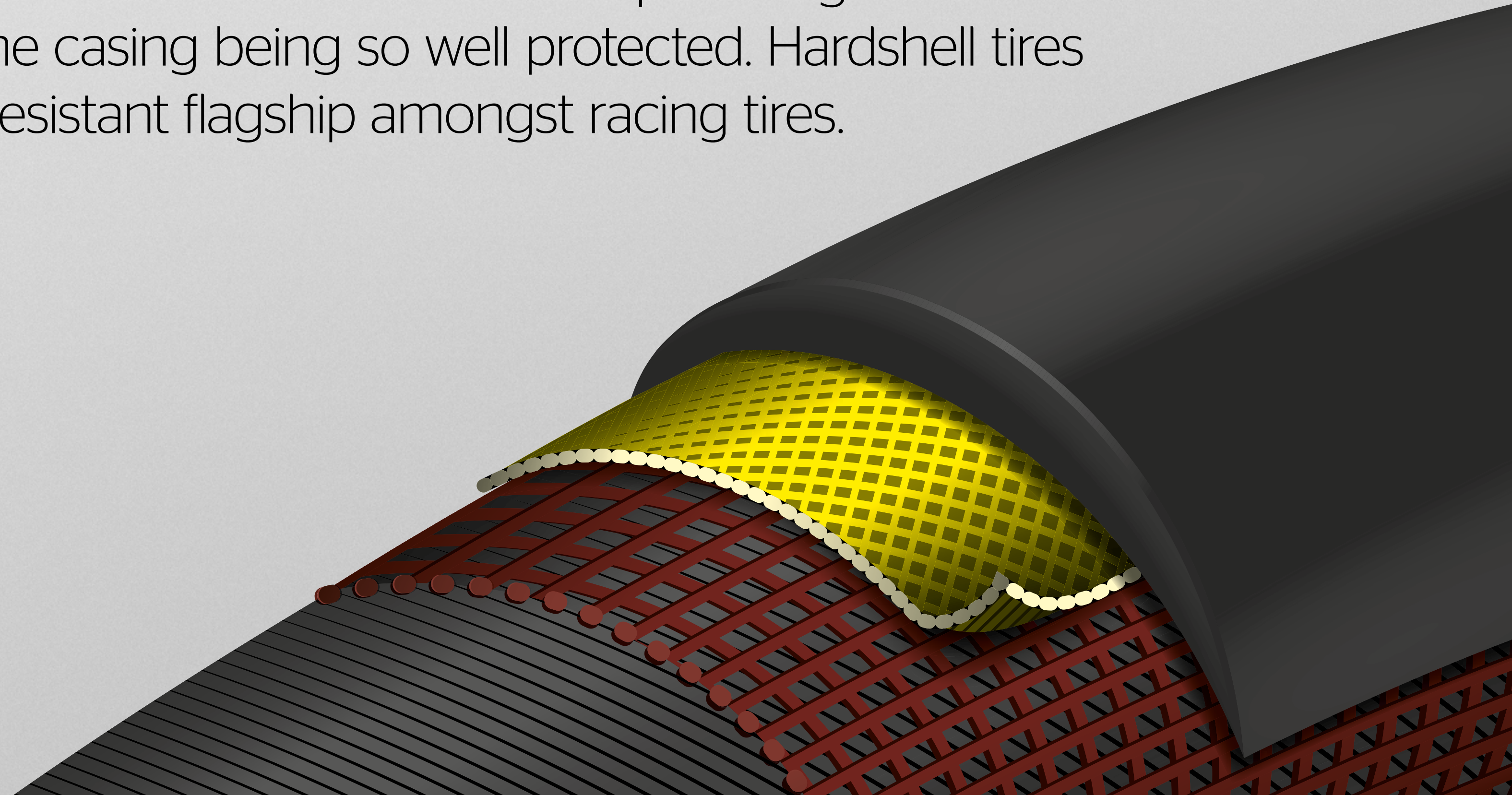

CUT AND PUNCTURE PROOF

Vectran is spun from liquid crystal-polymer. This way a thermoplastic, multiple-thread yarn is created. As a comparison: This partially crystalline fabric is more cut-resistant than aramide and its tensile strength is five times higher than that of steel. A Vectran breaker is lighter, more flexible and effective against cuts than a comparable nylon breaker. Without effecting rolling resistance.

Vectran[™]
BREAKER



FOR HARD CASES

Tires with DuraSkin® sidewall protection can take a beating as they are designed for the most adverse conditions. In rough terrain on a cyclocross or a gravel bike, on commuter bikes where tires scrape along curbs, on touring bikes as they cross continents encountering many different road qualities and on the race circuit where they prove themselves in endurance events such as the Paris-Roubaix. The high-quality polyamide fabric reliably protects the wall of the tire. Tires with DuraSkin® can be identified by the characteristic brown mesh sidewall.



SAFETY LEVEL



1

2

3

4

5

6

7



LIGHTWEIGHT PUNCTURE PROTECTION

The new SafetyPro Breaker designed from nylon textile. Cross-woven textile fiber netting that is simultaneously robust and flexible. Maximum puncture protection with minimal added weight. The risk of punctures resulting from glass or sharp stones is substantially reduced.

Safety  **Pro**

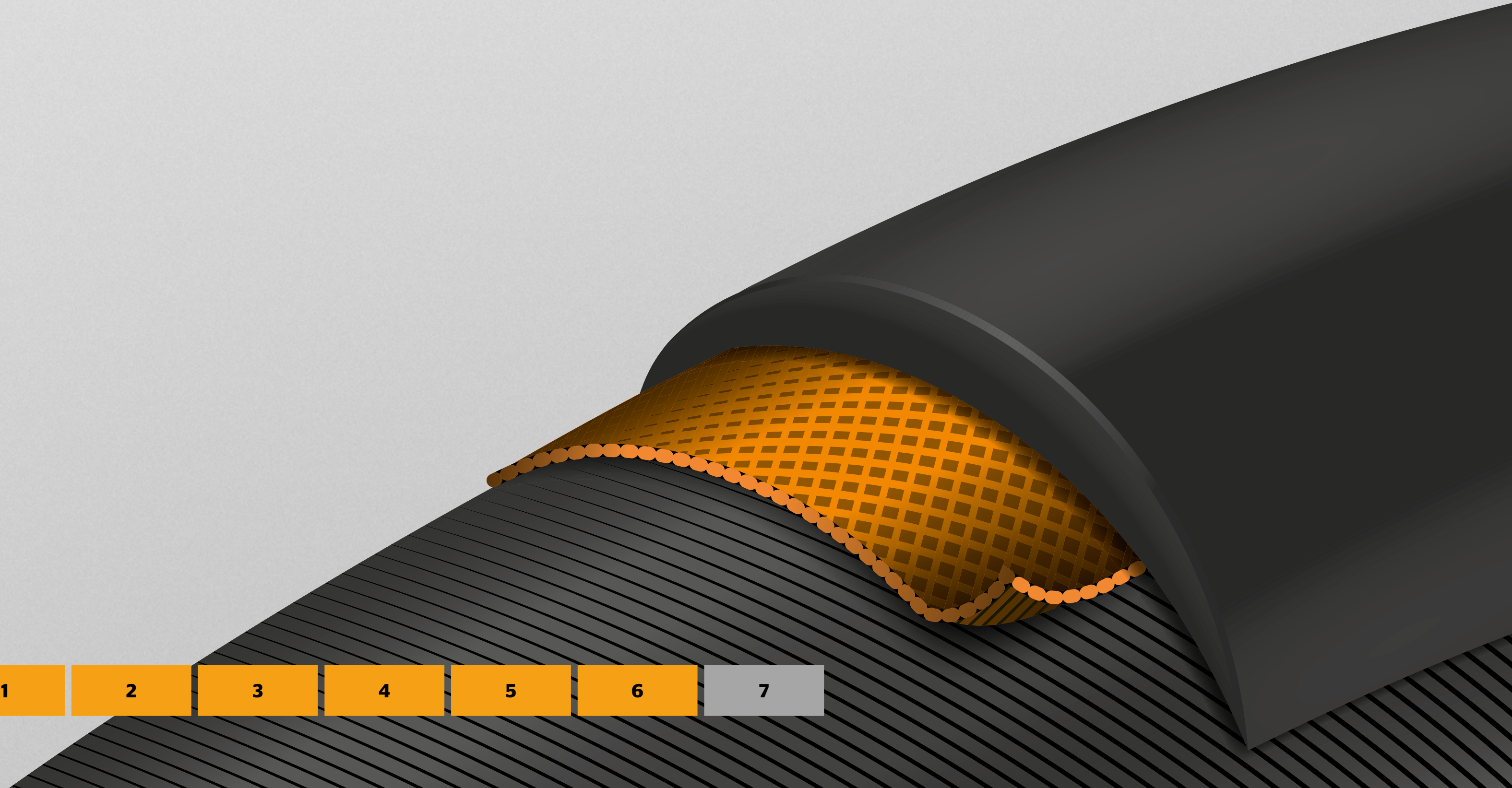

EXTRA PunctureBelt

CAREFREE ON A DAILY BASIS

Anyone looking for a reliable everyday companion will go for a tire with EXTRA PunctureBelt. This rugged rubber breaker, combined with the rubber-reinforced sidewalls of the tire, ensures a high level of puncture protection and sidewall abrasion. Where durability is the main focus, there is also a solid tire version.



THE NAME SPEAKS FOR ITSELF

An impeccable rubber Breaker, created for the daily ride on your Urban/Tour bike. The breaker ensures a high level of puncture protection and sidewall abrasion.



SafetyPlus Breaker

THE ANTI-PUNCTURE SPECIALIST

Specially designed for e-bikes up to 50 km/h, we have combined our SafetySystem Breaker with a highly flexible natural rubber. The result is an extremely cut and puncture resistant breaker ply which has a low rolling resistance thanks to its high elasticity. This helps saving battery life and the environment. High acceleration torques and fast speeds in turns are easily absorbed by the breaker. The specialist for fast e-bikes and rental bikes.

Safety 

SAFETY LEVEL



1

2

3

4

5

6

7



SafetySystem Breaker

PUNCTURE PROTECTION AS A SYSTEM

The SafetySystem Breaker consists of a Kevlar-reinforced, high-strength nylon fabric. Puncture and cut resistant, whilst also being light and flexible, allowing the tire to adapt more effectively to the terrain. The breaker protects the carcass against foreign objects and contributes to a longer lifespan of the tire without significantly increasing weight or rolling resistance. Additionally, tires with SafetySystem have particularly comfortable handling characteristics.

Safety  **System**

SAFETY LEVEL



1

2

3

4

5

6

7



SafetyPlus Pro Breaker

THE SPECIALIST FOR E-BIKES AND CARGO BIKES

Engineered for the unique demands of modern e-bikes and cargo bikes up to 50 km/h. Our SafetyPlus Pro Breaker technology combines highly flexible rubber with the proven strength of our tightly woven PolyX puncture-resistant fibers. The high elasticity keeps rolling resistance low, prolonging the e-bike battery life so you get more miles from each charge. When riding with heavy loads, the SafetyPlus Pro Breaker contributes to confident handling through busy traffic and sharp corners, no matter the conditions.

Safety **+** **Pro**

SAFETY LEVEL



1

2

3

4

5

6

7



Tires and Sizes



SIZES
12" - 27.5"

12"**62-203**

RIDE Tour

16"**35-349**

CONTACT Urban

47-305

RIDE Tour

20"**28-406**

CONTACT Speed

32-406

CONTACT Urban

37-406

CONTACT

42-406

CONTACT Urban

47-406

RIDE Tour

50-406

eCONTACT Plus

CONTACT Urban

55-406

eCONTACT Plus

62-406

eCONTACT Plus

24"**47-507**

RIDE Tour

26"**23-571**

Grand Prix

Gatorskin

26 x 22

Sprinter

28-559

Grand Prix

Gatorskin

32-559

CONTACT Speed

42-559

CONTACT Speed

47-559

Hometrainer II

CONTACT Plus

CONTACT Plus City

CONTACT

CONTACT Urban

47-559

RIDE Tour

RIDE City

50-559

Cross King ShieldWall

Race King ShieldWall

Top CONTACT II

Top CONTACT Winter II Premium

CONTACT Urban

CONTACT Speed

55-559

Cross King ProTecton

Cross King ShieldWall

eCONTACT Plus

Top CONTACT Winter II Premium

CONTACT Urban

58-559

Mountain King ProTecton

Mountain King ShieldWall

Cross King ProTecton

Cross King ShieldWall

Cross King

26/27.5"**37-584**

RIDE Tour

42-584

RIDE Tour

50-584

Pure CONTACT

54-584

RIDE Tour

55-584

Pure CONTACT

60-584

Pure CONTACT

27"**28-630**

Super Sport Plus

32-630

Gator Hardshell

Gatorskin

Super Sport Plus

RIDE Tour

37-609

RIDE Tour

27.5"**25-584**

Grand Prix 5000

Ultra Sport III

28-584

Grand Prix 5000

Ultra Sport III

30-584

Grand Prix 5000 S TR

32-584

Grand Prix 5000 S TR

CONTACT Speed

35-584

Terra Speed ProTecton

40-584

Terra Trail ProTecton

Terra Speed ProTecton

42-584

CONTACT Urban

47-584

Terra Trail ShieldWall

50-584

Hometrainer II

Cross King ShieldWall



Tires and Sizes



SIZES
12" - 27.5"

50-584

Race King ShieldWall

Top CONTACT Winter II Premium

CONTACT Urban

CONTACT Speed

54-584

Ruban ShieldWall

55-584

Cross King ProTecton

Cross King ShieldWall

Race King ProTecton

Race King ShieldWall

Race King

eCONTACT Plus

CONTACT Plus City

CONTACT Urban

58-584

Ruban

Ruban ShieldWall

Mountain King ProTecton

Mountain King ShieldWall

Mountain King

Cross King ProTecton

Cross King ShieldWall

58-584

Cross King

60-584

Xynotal

Kryptotal Fr

Kryptotal Re

Argotal

Hydrotal

62-584

eCONTACT Plus

CONTACT Urban

65-584

Kryptotal Re

Argotal

Ruban

Ruban ShieldWall

Mountain King ProTecton

Mountain King ShieldWall

Cross King ProTecton

Cross King ShieldWall

70-584

Mountain King ProTecton

Mountain King ShieldWall

Cross King ProTecton

70-584

Cross King ShieldWall

28"**23-622**

Grand Prix 5000

Grand Prix 4-Season

Grand Prix

Gator Hardshell

Gator Hardshell Black Edition

Gatorskin

Gatorskin Black Edition

Grand Sport Race

Ultra Sport III

Hometrainer II

Super Sport Plus

25-622

Grand Prix 5000

Grand Prix 4-Season

Grand Prix

Gator Hardshell

Gator Hardshell Black Edition

Gatorskin

Gatorskin Black Edition

Grand Sport Race

25-622

Ultra Sport III

Super Sport Plus

26-622

AERO 111

28-622

Grand Prix 5000

Grand Prix 4-Season

Grand Prix

Gator Hardshell

Gator Hardshell Black Edition

Gatorskin

Gatorskin Black Edition

Grand Sport Race

Ultra Sport III

Top CONTACT II

Super Sport Plus

CONTACT

CONTACT Urban

CONTACT Speed

RIDE Tour

28 x 19

Competition

Tempo II

28 x 22

Competition

Sprinter

Sprinter Gatorskin

Giro

Tempo II

28 x 23

Sonderklasse II

28 x 25

Competition

Sprinter

Sprinter Gatorskin

29-622

AERO 111

30-622

Grand Prix 5000

Grand Prix 5000 S TR

32-622

Grand Prix 5000

Grand Prix 5000 S TR

Grand Prix 5000 All Season TR

Grand Prix 4-Season

Gator Hardshell

Gator Hardshell Black Edition



Tires and Sizes



SIZES
12" - 27.5"

32-622

Gatorskin

Gatorskin Black Edition

Grand Sport Race

Hometrainer II

Top CONTACT II

CONTACT

CONTACT Urban

CONTACT Speed

CONTACT Spike 120

RIDE Tour

35-622

Grand Prix 5000 All Season TR

Grand Prix Urban

Urban TaraxaGum

Terra Speed ProTecton

Terra Trail ShieldWall

CONTACT Urban

37-622

Top CONTACT II

Top CONTACT Winter II Premium

CONTACT Plus

CONTACT Plus City

CONTACT

37-622

CONTACT Urban

CONTACT Speed

CONTACT Spike 120

CONTACT Spike 240

RIDE Tour

RIDE City

37-635

RIDE Tour

40-622

Terra Trail ProTecton

Terra Speed ProTecton

Terra Trail ShieldWall

Pure CONTACT

CONTACT Urban

42-622

Top CONTACT II

Top CONTACT Winter II Premium

CONTACT Plus

CONTACT Plus City

CONTACT

CONTACT Urban

CONTACT Speed

CONTACT Spike 120

42-622

CONTACT Spike 240

RIDE Tour

RIDE City

42-635

CONTACT Plus

RIDE Tour

45-622

Terra Trail ShieldWall

Terra Speed ProTecton

47-622

Pure CONTACT

Top CONTACT II

CONTACT Plus

CONTACT Plus City

CONTACT

CONTACT Urban

RIDE Tour

RIDE City

50-622

Terra Hardpack ShieldWall

eCONTACT Plus

CONTACT Urban

55-622

CONTACT Urban

CONTACT Cruiser

RIDE Cruiser

62-622

eCONTACT Plus

CONTACT Urban

29"**50-622**

Cross King ShieldWall

Race King ShieldWall

Pure CONTACT

54-622

Ruban

Ruban ShieldWall

55-622

Cross King ProTecton

Cross King ShieldWall

Cross King

Race King ProTecton

Race King ShieldWall

Race King

Pure CONTACT

58-622

Ruban

Ruban ShieldWall

Mountain King ProTecton

Mountain King ShieldWall

Mountain King

Cross King ProTecton

Cross King ShieldWall

Cross King

60-622

Xynotal

Kryptotal Fr

Kryptotal Re

Argotal

Hydrotal

65-622

Kryptotal Re

Argotal

Ruban ShieldWall

Cross King ShieldWall



Tubes



TPU



WORKSHOP



HERMETIC PLUS



COMPACT



With the **ContiTube program**, you can find the inner tube most suited to your needs. Depending on your tire dimensions and purpose, different sizes, types, valve types and widths are available.

All

The all-rounder for day to day demands. Available in all usual dimensions.

Light und Supersonic

Perceptible optimization of weight and rolling resistance due to thinner material.

! Light tubes generally require more frequent reinflating.

Hermetic Plus

The all-round carefree product. Designed for the most comprehensive puncture protection and air retention due to enhanced butyl content and increased wall thickness.

Freeride und Downhill

Extra strong and increased volume. Effectively protects against punctures thanks to thicker material.

TPU

Small but mighty. Highest grade of micrometer-thick TPU deployed across seven sealed layers. Suitable for road and off-road riders.

TPU TUBES

A seven-layer lightweight TPU Inner Tube for performance-focused and space-saving road, gravel and MTB riders.

Available in a wide range of sizes from 25/35-622, **ContiTPU** is premium, lightweight yet durable and suitable for both road and off-road riders.

The highest grade of micrometer-thick TPU deployed across seven sealed layers maximises airtightness and durability. The tubes are uncoloured to further ensure the highest material

quality and prevent air retention issues caused by dye-related surface imperfections. Every ContiTPU tube is quality-checked post-production. The base of the valve shaft is slightly conical in shape to improve fit to the wheel rim and reduce unwanted movement, while the valve is internally threaded to allow for the use of valve extensions or a replacement valve core.



TPU



WORKSHOP



HERMETIC PLUS



COMPACT



Auto Schrader



Blitz Dunlop



Sclaverand Presta



Sclaverand Presta



Sclaverand Presta

A34	A34 45°	A40	D26	D40	S42	S60	S80
-----	---------	-----	-----	-----	-----	-----	-----

TPU											
ETRTO	Version	Article	Article	Article	Article	Article	Article	Article	Article	g	RRP €
28"											
40-584->60-584	TPU							0182611		43	29,95
25-622->35-622	TPU							0182621		35	29,95
40-622->60-622	TPU							0182631		43	29,95

Tubes



TPU



WORKSHOP



HERMETIC PLUS



COMPACT



Lightweight



Easy to repair
(enclosed repair kit)

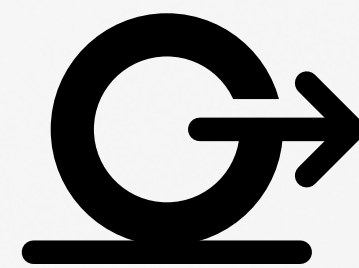

Low rolling resistance

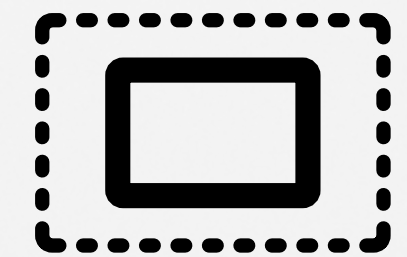

Small Packing size



IMPORTANT INFORMATION



TPU



WORKSHOP



HERMETIC PLUS



COMPACT

1. TPU tubes must never be used in conjunction with rim brakes. Excessive heat exposure can lead to a sudden loss of air pressure.

2. Use suitable rim tape to protect the TPU tube. Otherwise, it can become damaged.

3. During mounting, the TPU tubes must not be inflated over 0.3 bar. Over-inflation during this part of the process can excessively stretch the tube and render it unusable.

4. Ensure the valve hole in the rim is the correct diameter. If the valve hole is too large, the valve can twist or shear off.

5. Pay close attention when mounting the tube. Always ensure the tube or valve isn't trapped, twisted or damaged.

6. TPU tubes must never be re-used with a smaller tire! If you are mounting a smaller tire, then it is necessary to use a new tube.

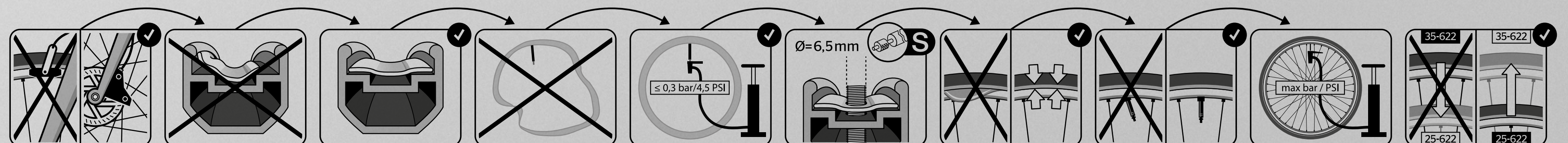

Tubes



Auto Schrader



Blitz Dunlop



Sclaverand Presta



Sclaverand Presta



Sclaverand Presta

- A34
- A34 45°
- A40
- D26
- D40
- S42
- S60
- S80

Workshop (50 Stück/VE)											
ETRTO	Version	Article	Article	Article	Article	Article	Article	Article	Article	g	RRP €
26"											
47-559->62-559	MTB			0180581			0180521	0180551			205
26" (27.5")											
37-559->47-597	Tour						0180621				175
	Tour Hermetic Plus						0180751				255
27.5"											
47-584->62-584	MTB							0182351			230
28" / 29"											
18-622->25/630	Race							0180591	0180611	0180024	100
32-622->47-642	Tour			0180691			0180651	0180681			165
	Tour Hermetic Plus			0180721			0180711				225
47-622->62-622	MTB							0182361			235
Race 26"											
20-559->25-571								0181371	0181381		95
	Light							0181391	0181411		65
	Supersonic							0181421	0181431		50
Race 28"											
20-622->25-630								0181781	0181791	0180000	100
	Light							0181821	0181831	0181871	65
	Supersonic							0181881	0181891		50
25-622->32-630	Wide							0181921	0181931		125
Cross 28"											
32-622->47-622								0181941	0181951		160
											starts with 7,50



TPU



WORKSHOP



HERMETIC PLUS



COMPACT



Tubes



Auto Schrader



Blitz Dunlop



Sclaverand Presta



Sclaverand Presta



Sclaverand Presta

A34	A34 45°	A40	D26	D40	S42	S60	S80
-----	---------	-----	-----	-----	-----	-----	-----

ETRTO	Version	Article	Article	Article	Article	Article	Article	Article	g	RRP €
MTB 26"										
47-559->62-559				0181611		0181621	0181631	0181671	205	starts with 7,50
47-559->60-559	Light						0181681		125	9,50
47-559->55-559	Supersonic						0181691		100	13,50
57-559->70-559	Freeride			0181721			0181731		295	12,50
	Downhill			0181771					535	12,50
MTB 27.5"										
47-584->62-584				0182331			0182311		230	7,50
47-584->60-584	Light						0182341		145	9,50
65-584->70-584	Wide			0180017			0180015		345	9,50
	Wide Light						0180019		275	9,50
MTB 29"										
47-622->62-622				0182171		0183051	0182181	0182191	230	starts with 7,50
47-622->60-622	Light						0182321	0182201	190	starts with 9,50
65-622->70-622	Wide			0180031			0180034		345	9,50
Tour 26"										
28-559->32-597	Slim					0181471	0181481		145	7,50
37-559->47-590	All			0181491		0181511	0181521		175	7,50
47-559->62-559	Wide			0181531		0181571	0181591		200	7,50
Tour 28"										
28-622->37-622/32-630	Slim			0181971		0181981	0181991		140	7,50
32-622->47-622/42-635	All			0182001		0182021	0182031	0182041	165	starts with 7,50
	Light			0182051		0182061	0182071		115	9,50
47-622->62-622	Wide			0182121		0182131	0182161		230	7,50



TPU



WORKSHOP



HERMETIC PLUS



COMPACT



Tubes



Auto Schrader



Blitz Dunlop



Sclaverand Presta



Sclaverand Presta

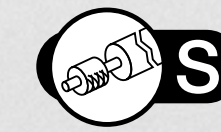

Sclaverand Presta

- A34
- A34 45°
- A40
- D26
- D40
- S42
- S60
- S80

Hermetic Plus											
ETRTO	Version	Article	Article	Article	Article	Article	Article	Article	Article	g	RRP €
Compact 20"											
32-406->47-451		0180037				0180039				190	9,50
50-406->62-406	Wide	0180042				0180045				230	9,50
Compact 24"											
32-507->47-544				0182231		0182241				235	9,50
55-507->62-507	Wide			0182581						370	9,50
Tour 26"											
37-559->47-590	All			0182251		0182261	0182271			255	9,50
47-559->62-559	Wide					0181581				300	9,50
Tour 28"											
32-622->47-622/42-635	All			0182101		0182081	0182091			225	9,50
47-622->62-622	Wide					0182151				325	9,50



TPU



WORKSHOP



HERMETIC PLUS



COMPACT



Tubes



A34

A34 45°

A40

D26

D40

S42

S60

S80

Compact Tubes

ETRTO	Version	Article	Article	Article	Article	Article	Article	Article	Article	g	RRP €
-------	---------	---------	---------	---------	---------	---------	---------	---------	---------	---	-------

Compact 8"

54-110					0180991					70	7,50
--------	--	--	--	--	---------	--	--	--	--	----	------

Compact 10" /11" / 12"

44-194->62-222		0181051	0182211		0181071					95	7,50
----------------	--	---------	---------	--	---------	--	--	--	--	----	------

Compact 14"

32-279->47-298					0181081					100	7,50
----------------	--	--	--	--	---------	--	--	--	--	-----	------

Compact 16"

32-305->47-349		0181091			0181111		0181121			110	7,50
----------------	--	---------	--	--	---------	--	---------	--	--	-----	------

50-305->62-305	Wide	0181131			0181171					120	7,50
----------------	------	---------	--	--	---------	--	--	--	--	-----	------

Compact 18"

32-355->47-400				0180026	0181181					125	7,50
----------------	--	--	--	---------	---------	--	--	--	--	-----	------

Compact 20"

28-406->32-451	Slim						0181191			105	7,50
----------------	------	--	--	--	--	--	---------	--	--	-----	------

32-406->47-451		0181211				0181221	0181231			135	7,50
----------------	--	---------	--	--	--	---------	---------	--	--	-----	------

50-406->62-406	Wide	0181271				0181281				155	7,50
----------------	------	---------	--	--	--	---------	--	--	--	-----	------

Compact 24"

32-507->47-544				0181291		0181311	0180027			155	7,50
----------------	--	--	--	---------	--	---------	---------	--	--	-----	------

50-507->60-507	Wide			0181321		0181331				195	7,50
----------------	------	--	--	---------	--	---------	--	--	--	-----	------



TPU



WORKSHOP



HERMETIC PLUS



COMPACT



TIPS AND TRICKS

In individual cases where the tire bead does not properly sit on the inside of the rim, try unscrewing the valve nut and pushing the valve back. Valves with a round rubber end have a lower volume than those with a rectangular rubber end. Maybe you could try to change your existing valve to fit your tire accordingly.



INSTRUCTION 1 - 3



INSTRUCTION 4 - 6



INSTRUCTION 7 - 9



RECOMMENDED AMOUNTS OF SEALANT PER TIRE

	<i>Dimension</i>	<i>Filling amount</i>
ROAD	25 mm	30 - 60 ml
	28 mm	60 - 90 ml
MTB	2.0 - 2.1	80 - 100 ml
	2.2 - 2.3	100 - 120 ml
	2.4 - 2.5	120 - 150 ml
	2.6 - 2.8	150 - 180 ml



INSTRUCTION 1-3



INSTRUCTION 4-6



INSTRUCTION 7-9

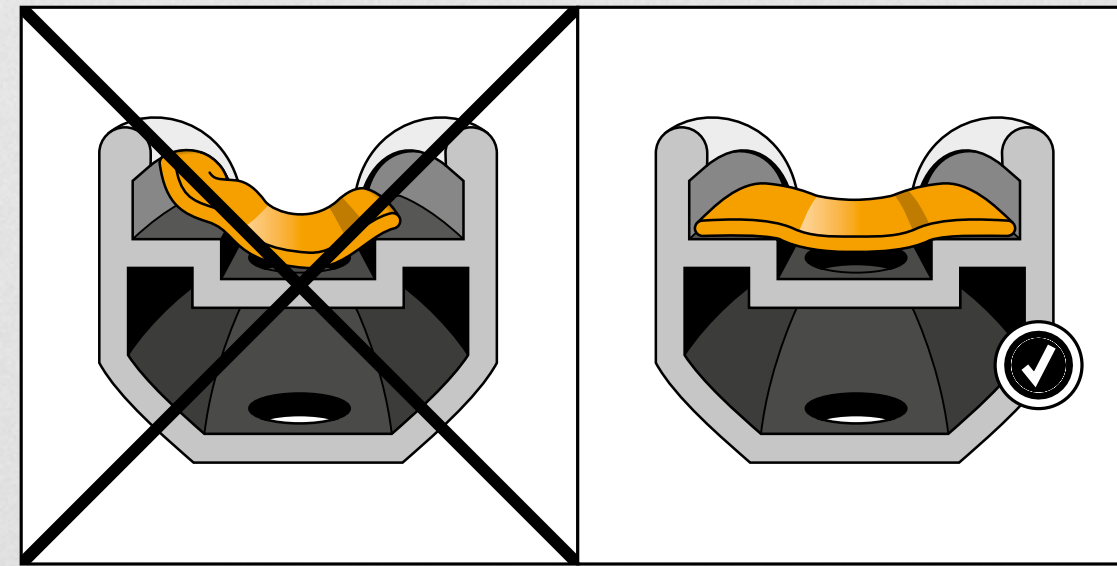

1 Check both rim and rim tape. Only use Tubeless ready rims. Ensure that the rim tape covers the rim well with at least two layers.

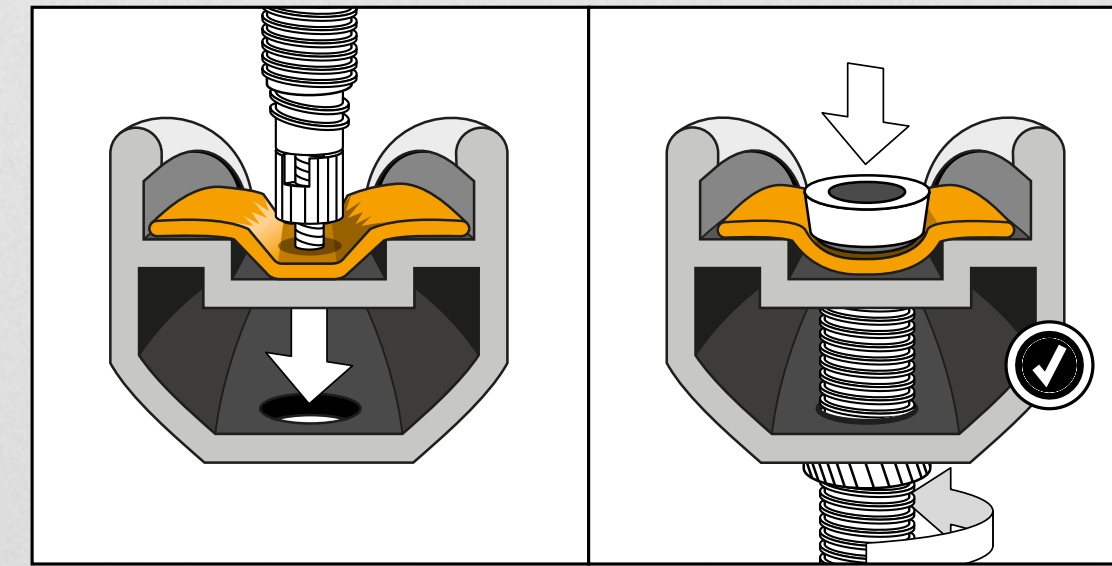

2 Mount the Tubeless valve first. Install it from the inside of the rim and tighten the nut. Press your finger on the rubber end of the valve to secure a better fit. Only tighten the nut by hand, do not use any tools.

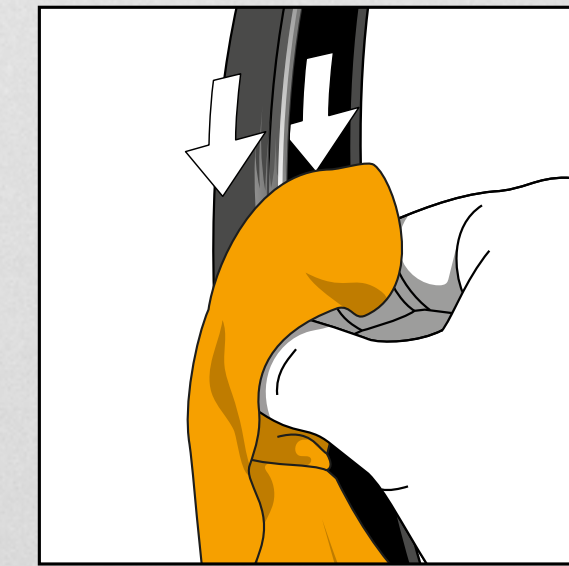

3 Before the initial inflation you can apply some soapy-water or a mounting pad on the contact points between tire and rim bed. This can help improve mounting the tire on the rim.





INSTRUCTION 1-3



INSTRUCTION 4-6



INSTRUCTION 7-9

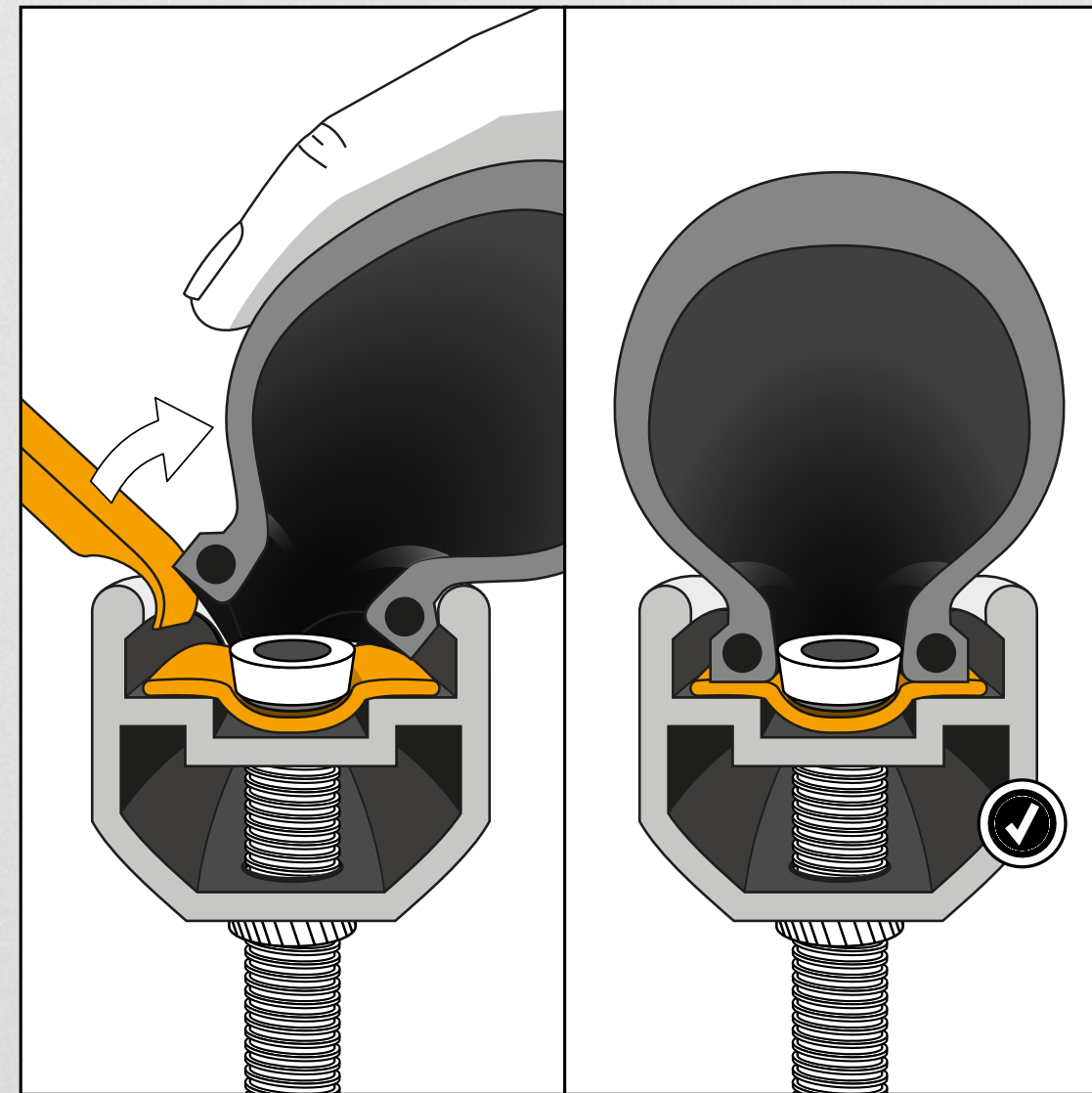

4 Mount the Tubeless tire on the rim in correct orientation of rotation. Ensure no loose pieces (e.g. sand, plastics) are found inside. Due to the tighter dimension tolerances of a Tubeless tire compared to a normal Clincher tire it may be helpful for you to use tire levers.

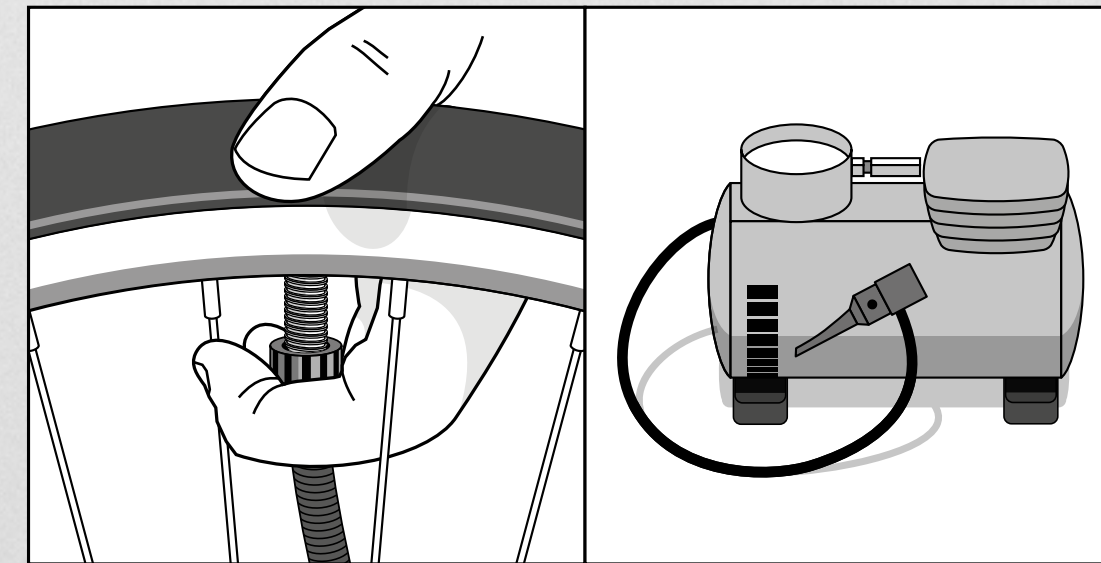

5 To fit the tire between the hooks, you may need a higher amount of air in the first instance. If you are using a floor pump, it is better to maintain a constant momentum within the first few seconds. A modern floor pump with a second inflatable cartridge can help to achieve this.

If a floor pump does not fill and accurately seat the tire, a compressor could help. You may need to adapt to the respective bicycle valve.

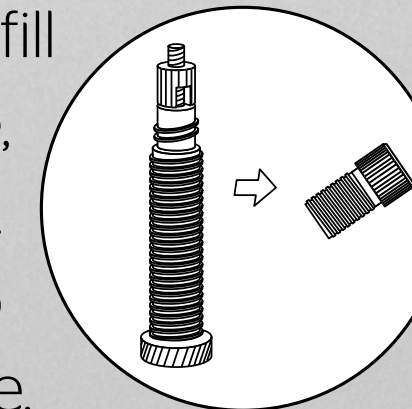

Please note, that the pressure in the size overview indicates the recommended pressure on the lower end and the maximum pressure on the upper end.

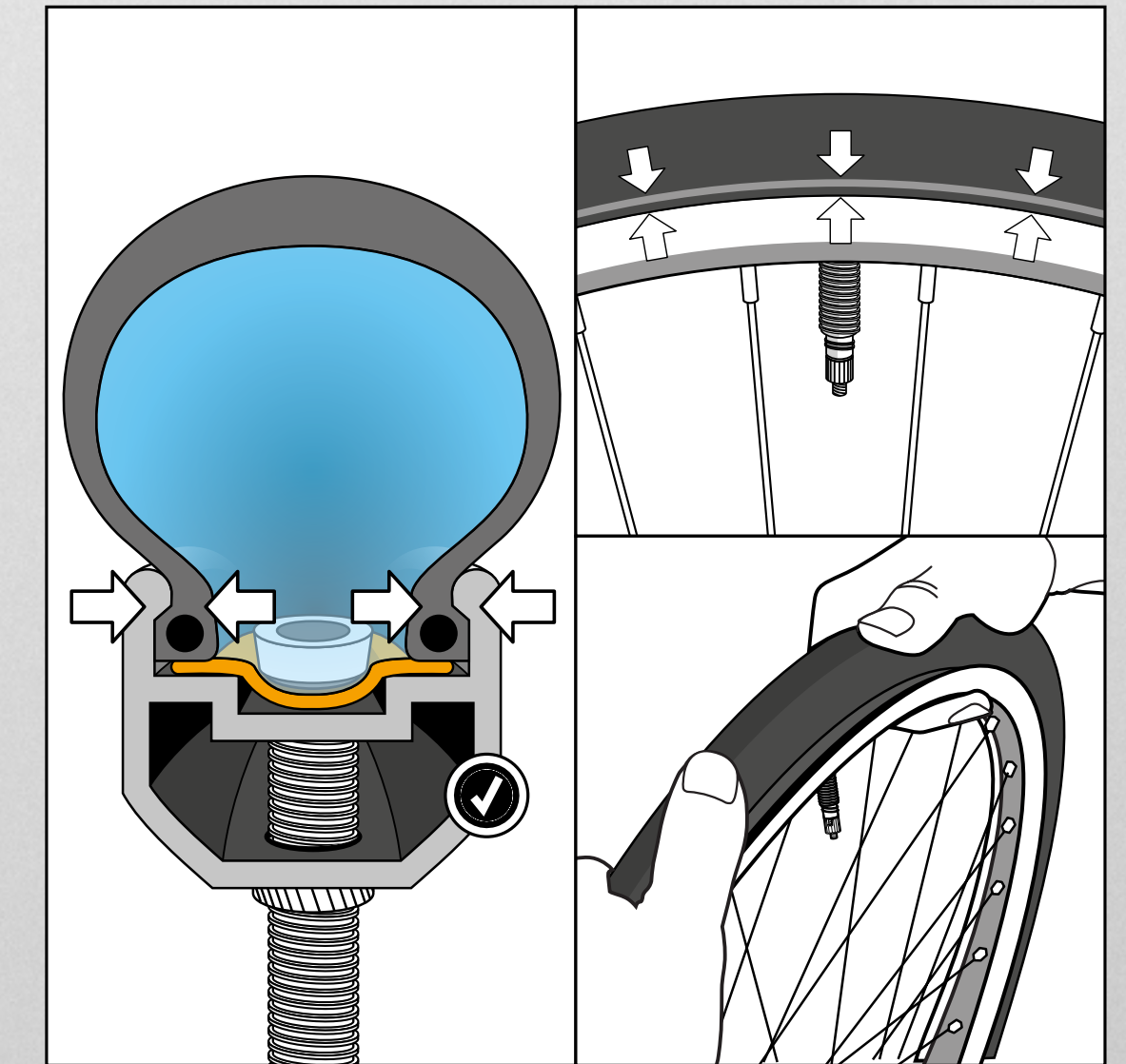

6 The correct fitting of the tire on the rim is mostly notable by a loud clicking noise. Check the air tightness of your Tubeless system. Does it lose any air? Check if the control line has an equal distance to the rim. If not release some air and work on the tire with both hands.





INSTRUCTION 1-3



INSTRUCTION 4-6



INSTRUCTION 7-9

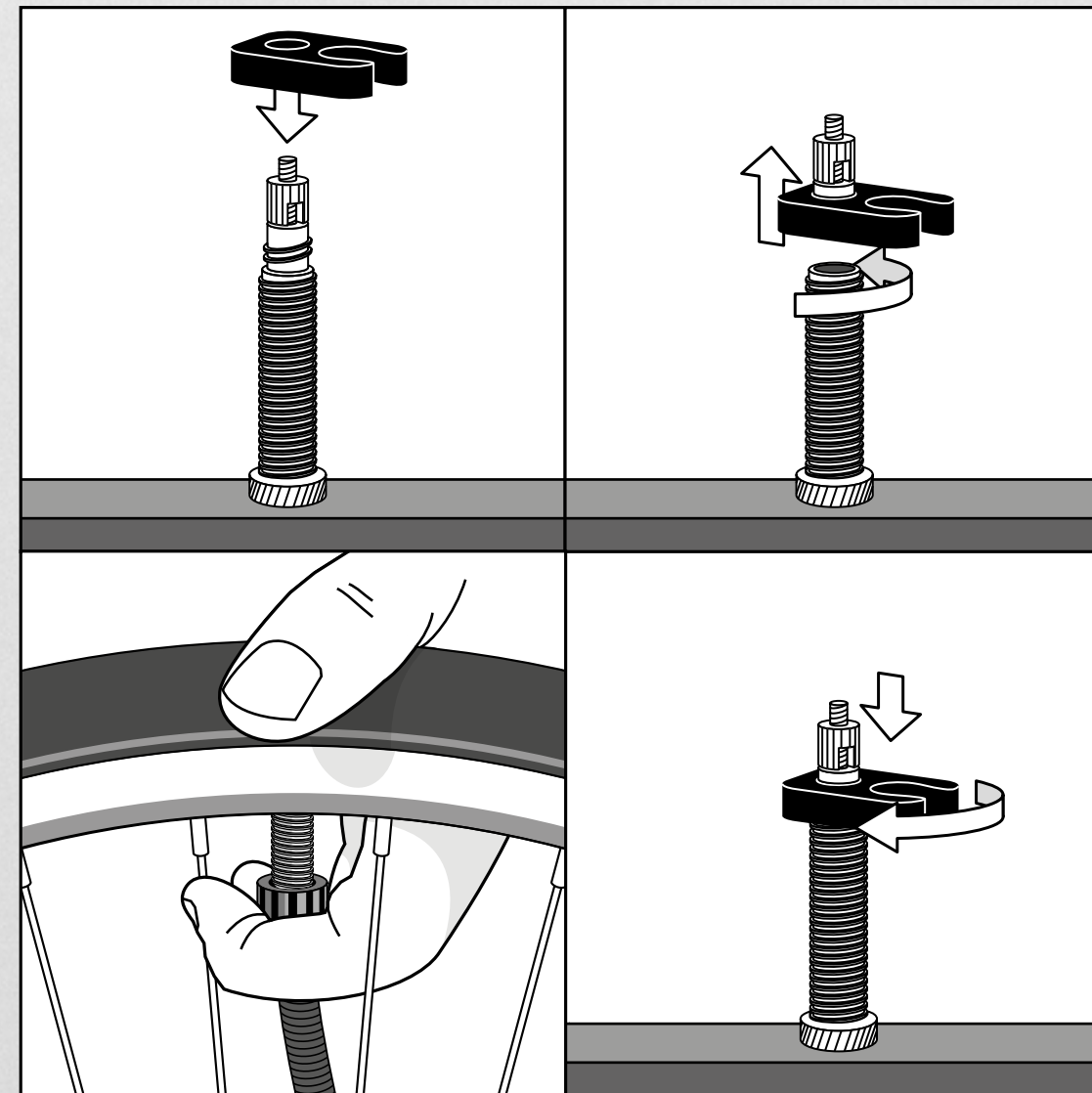

7 To enhance the air volume, unscrew the valve core. Pump it up and screw the valve core in again.



8 For the best puncture resistance, we recommend to fill approximately 30 - 60 ml of tire sealant through the valve. Considering it will dry over time, it is best to check and refill it every 3 - 6 months.

Important:

Do not insert the tire sealant with the valve at a 6 o'clock position! The valve should be located at the 5 or 7 o'clock position.

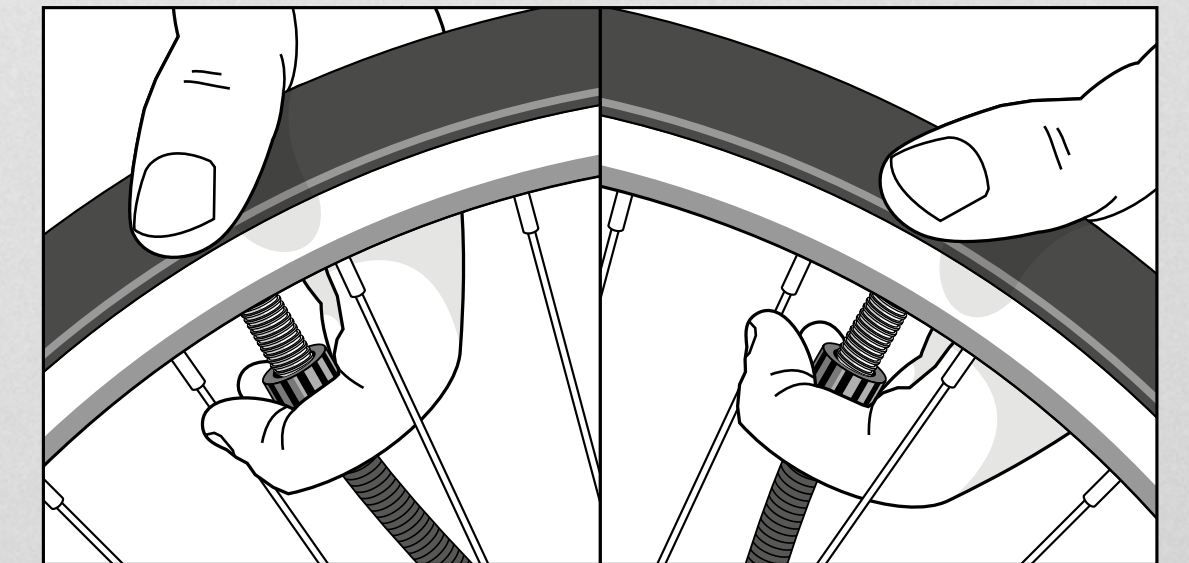

9 If you are using tire sealant: For inflation place the tire with the valve at the 11 or 1 o'clock position. Otherwise sealant could leak into the valve or put too much turbulence into it. It could dry faster or lock up the valve core.

Please be advised that the use of a CO2 cartridge can clump the sealant particles.





Continental Reifen Deutschland GmbH

Büttnerstraße 25
D-30165 Hannover

www.continental-tires.com/bicycle



Newsletter for
wholesale and retail
Subscribe here



[Conti on Facebook](#)



[Conti on Instagram
Road](#)



[Conti on Instagram
MTB](#)

Subject to technical changes.

No reliability for printer's error:

07/24 Barthelmay & Habedank Design GmbH.

Vectran™ is the registered trademark of Kuraray Co., Ltd.; Kevlar® is the registered trademark of E. I. du Pont de Nemours and Company.

© Copyright 2024 by

Continental Reifen Deutschland GmbH,
30165 Hannover, Germany